



Operator's Manual

Precedent™ Multi-Temperature Units C-600M, S-610M and S-610DE

Revision C

April 2022

TK 56171-2-OP-EN

TRANE
TECHNOLOGIES

Introduction

This manual is published for informational purposes only and the information furnished herein should not be considered as all-inclusive or meant to cover all contingencies. If more information is required, consult your Thermo King Service Directory for the location and telephone number of the local dealer.

Thermo King's warranty shall not apply to any equipment which has been "so installed, maintained, repaired or altered as, in the manufacturer's judgment, to affect its integrity."

Manufacturer shall have no liability to any person or entity for any personal injury, property damage or any other direct, indirect, special, or consequential damages whatsoever, arising out of the use of this manual or any information, recommendations or descriptions contained herein. The procedures described herein should only be undertaken by suitably qualified personnel. Failure to implement these procedures correctly may cause damage to the Thermo King unit or other property or personal injury.

There is nothing complicated about operating and maintaining your Thermo King unit, but a few minutes studying this manual will be time well spent.

Performing pre-trip checks and enroute inspections on a regular basis will minimize operating problems. A regular maintenance program will also help to keep your unit in top operating condition. If factory recommended procedures are followed, you will find that you have purchased the most efficient and dependable temperature control system available.

All service requirements, major and minor, should be handled by a Thermo King dealer for four very important reasons:

- They are equipped with the factory recommended tools to perform all service functions.
- They have factory trained and certified technicians.
- They have genuine Thermo King replacement parts.
- The warranty on your new unit is valid only when the repair and replacement of component parts is performed by an authorized Thermo King dealer.

Software License

The product includes software that is licensed under a non-exclusive, non-sublicensable, terminable and limited license to use the software as installed on the product for its intended purpose. Any removal, reproduction, reverse engineering, or other unauthorized use of the software is strictly prohibited. Hacking the product or installing unapproved software may void the warranty. The owner or operator shall not reverse engineer, decompile, or disassemble the software, except and only to the extent that such activity is expressly permitted by applicable law notwithstanding this limitation. The product may include third party software separately licensed as specified in any documentation accompanying the product or in an about screen on a mobile application or website that interfaces with the product.

Customer Satisfaction Survey

Let your voice be heard!

Your feedback will help improve our manuals. The survey is accessible through any internet-connected device with a web browser.

Scan the Quick Response (QR) code or click [Technical Publications TK Americas Feedback](#) to complete the survey.



Table of Contents

Safety Precautions	10
Danger, Warning, Caution, and Notice	10
General Safety Practices	10
Automatic Start/Stop Operation	11
Electrical Hazard	11
Battery Installation and Cable Routing	12
Refrigerant	13
Refrigerant Oil	14
First Aid	14
Safety Decals and Locations	17
Condenser and Evaporator Fans	17
High Voltage Components	17
California Proposition 65 Warning Nameplate	18
Unit Description	19
Unit Overview	19
Diesel Engine	20
Extended Life Coolant (ELC)	21
EMI 3000	21
Thermo King X430 Series Reciprocating Compressor	22
Electronic Throttling Valve	22
Remote Evaporators	22
SMART REEFER 4 (SR-4) Control System	22
Diesel Operation	23
Electric Operation	23
CYCLE-SENTRY™ Start-Stop Controls	23
Data Logging	24

OptiSet Plus™	26
FreshSet™	26
ECO Pulldown Mode	26
Defrost	27
Precision Temperature Control (PTC)	27
Opening the Front Doors	27
Engine Compartment Components	28
Unit Protection Devices	29
Base Controller Fuses	30
Expansion Module Fuses	30
ECU Interface Board Fuses	30
Battery Fuses	30
Manual Pretrip Inspection and Loading Procedures	31
Operating Instructions	33
SMART REEFER 4 Multi-Temp (SR-4 MT) Control System	33
Microprocessor On/Off Switch	34
SR-4 HMI Control Panel	34
Control Panel Display	35
Display Icons	36
Zone Cooling, Heating, or Null	36
ECO Pulldown Mode	38
Zone Level or Unit Level Alarm Codes	39
Hard Keys	39
Soft Keys	41
Turning The Unit On And Off	41

Two Zone Standard Display	43
Three Zone Standard Display	44
Single Zone Control Standard Display	45
Operating the Unit in Single Zone Control Mode	45
The TemperatureWatch™ Display.....	46
Changing the Setpoint	47
Turning a Zone On and Off	50
Starting the Diesel Engine	52
Starting the Electric Motor.....	53
Switching from Diesel to Electric.....	54
Switching from Electric to Diesel.....	55
Initiating a Manual Defrost Cycle.....	56
Terminating a Defrost Cycle	59
Selecting Cycle Sentry or Continuous Mode	59
Using the Main Menu	62
Main Menu Choices	62
Pretrip	64
Pretrip Test Conditions	64
Conditions Where Pretrip Tests Are Not Allowed	64
Pretrip Test Considerations.....	64
Pretrip Test Sequence	65
Performing a Pretrip Test	66
Flash Drive	69
Download	69
Flashload	69
Flash Drive Icon	69
Selecting the Flash Drive Menu from the Main Menu (If Already Connected)	70
Flash Drive (If Connected While the Unit is Turned On)	71

Removing the Flash Drive	71
Languages	72
Available Languages	72
Selecting an Alternate Language	72
Language Menu Quick Access	74
Alarms	75
Log Alarm	75
Check Alarm	76
Unit Level Check Alarm	76
Zone Level Check Alarm	77
Unit Level Prevent Alarm	77
Zone Level Prevent Alarm	77
Shutdown Alarm	78
Unit Level Shutdown Alarm	78
Zone Level Shutdown Alarm	78
Pretrip Alarm	79
Zone Off Alarm	79
Low Battery Voltage	79
Alarm Codes When Switching Between Diesel and Electric	79
Clearing Alarm Codes	79
Displaying and Clearing Alarm Codes	80
Important Alarm Notes	83
Gauges	84
Displaying Gauges	84
Gauges Available	85
Sensors	86
Displaying Sensors	86
Sensors Available	87
Data Logger (CargoWatch™)	89
Sending Start of Trip Marker to CargoWatch and ServiceWatch Data Loggers	90
Printing CargoWatch Data Logger Reports	90
Hourmeters	92
Viewing Hourmeters	92
Hourmeter Names and Definitions	94

Mode	95
Using the Change Mode Menu	96
Turn Cycle Sentry On or Off	97
Using the Cycle Sentry Key	97
Using the Main Menu	98
Single Zone Control - Multi Zone Control	99
Select Temperature Units	100
Keypad Lockout	100
Start Sleep Mode	101
SmartPower™ Electric Standby Option	102
Electric Mode Operation	103
Diesel Mode Operation	103
Switching from Diesel to Electric	103
Electric Standby Power Fails or is Disconnected	104
Switching from Electric to Diesel	105
Adjust Brightness	106
Time	107
Clear All ECU Faults	108
Alarm Codes.....	111
Introduction	111
Alarm Types	111
Log Alarms	111
Check Alarms	112
Unit Level Prevent Alarms	112
Zone Specific Prevent Alarms	113
Unit Level Shutdown Alarms	113
Zone Specific Shutdown Alarms	114
Pretrip Alarm Codes	114
Clearing Alarm Codes	114
Loading and Inspection Procedures.....	125
Pre-Loading Inspection	125

Single Temperature Loading Procedures	126
Post-Loading Inspection.....	127
Post Trip Checks.....	128
Enroute Inspections.....	128
Inspection Procedure	128
Inspection Troubleshooting	128
Jump Starting	131
Specifications	135
Engine.....	135
Refrigeration System	136
Electrical Control System.....	136
Electrical Standby (SmartPower Unit Only)	137
Electric Motor and Overload Relay.....	137
Standby Power Cord Requirements (SmartPower Units Only).....	137
Maintenance Inspection Schedule	138
Host Unit.....	138
Remote Evaporator(s).....	142
Serial Number Locations	144
Emergency Cold Line	146
Warranty.....	147
EPA and ARB Supplemental Emissions Warranty Statement.....	147
CALIFORNIA Proposition 65 Warning	148

Safety Precautions

Danger, Warning, Caution, and Notice

Thermo King® recommends that all service be performed by a Thermo King dealer and to be aware of several general safety practices.

Safety advisories appear throughout this manual as required. Your personal safety and the proper operation of this unit depend upon the strict observance of these precautions. The four types of advisories are defined as follows:

▲ DANGER

Hazard!

Indicates an imminently hazardous situation which, if not avoided, will result in death or serious injury.

▲ WARNING

Hazard!

Indicates a potentially hazardous situation which, if not avoided, could result in death or serious injury.

▲ CAUTION

Hazard!

Indicates a potentially hazardous situation which, if not avoided, could result in minor or moderate injury and unsafe practices.

NOTICE

Hazard!

Indicates a situation that could result in equipment or property-damage only accidents.

General Safety Practices

▲ DANGER

Risk of Injury!

Keep hands and loose clothing clear of fans and belts at all times when the unit is operating with the doors open.

⚠ WARNING

Risk of Injury!

Do not apply heat to a closed cooling system. Before applying heat to a cooling system, drain it. Then flush it with water and drain the water. Antifreeze contains water and ethylene glycol. The ethylene glycol is flammable and can ignite if the antifreeze is heated enough to boil off the water.

⚠ CAUTION

Sharp Edges!

Exposed coil fins can cause lacerations. Service work on the evaporator or condenser coils should only be accomplished by a certified Thermo King technician.

Automatic Start/Stop Operation

⚠ CAUTION

Risk of Injury!

The unit can start and run automatically any time the unit is turned on. Turn the unit On/Off switch Off before doing inspections or working on any part of the unit. Please note that only Qualified and Certified personnel should attempt to service your Thermo King unit.

Electrical Hazard

⚠ DANGER

Hazardous Voltage!

Dangerous three phase AC electric power is present whenever the unit is operating in either Diesel Mode or Electric Mode and whenever the unit is connected to a source of external standby power. Voltages of this magnitude can be lethal. Exercise extreme caution when working on the unit. If there is a risk of energized electrical contact, arc, or flash, technicians **MUST** put on all PPE in accordance with OSHA, NFPA 70E, or other local, state, or country-specific requirements for arc flash protection **PRIOR** to servicing the unit. **NEVER PERFORM ANY SWITCHING, DISCONNECTING, OR VOLTAGE TESTING WITHOUT PROPER ELECTRICAL PPE AND ARC FLASHING CLOTHING. ELECTRICAL METERS AND EQUIPMENT MUST BE PROPERLY RATED FOR INTENDED VOLTAGE.**

Battery Installation and Cable Routing

⚠ WARNING

Hazard of Explosion!

An improperly installed battery could result in a fire, explosion, or injury. A Thermo King approved battery must be installed and properly secured to the battery tray.

⚠ WARNING

Hazard of Explosion!

Improperly installed battery cables could result in a fire, explosion, or injury. Battery cables must be installed, routed, and secured properly to prevent them from rubbing, chaffing, or making contact with hot, sharp, or rotating components.

⚠ WARNING

Fire Hazard!

Do not attach fuel lines to battery cables or electrical harnesses. This has the potential to cause a fire and could cause serious injury or death.

⚠ WARNING

Personal Protective Equipment (PPE) Required!

A battery can be dangerous. A battery contains a flammable gas that can ignite or explode. A battery stores enough electricity to burn you if it discharges quickly. A battery contains battery acid that can burn you. Always wear goggles or safety glasses and personal protective equipment when working with a battery. If you get battery acid on you, immediately flush it with water and get medical attention.

⚠ WARNING

Hazard of Explosion!

Always cover battery terminals to prevent them from making contact with metal components during battery installation. Battery terminals grounding against metal could cause the battery to explode.

⚠ CAUTION

Hazardous Service Procedures!

Set all unit electrical controls to the OFF position before connecting battery cables to the battery to prevent unit from starting unexpectedly and causing personal injury.

NOTICE

Equipment Damage!

Do not connect other manufacturer's equipment or accessories to the unit or to the TK Batteries unless approved by Thermo King. Failure to do so can result in severe damage to equipment and void the warranty.

Refrigerant

Although fluorocarbon refrigerants are classified as safe, use caution when working with refrigerants or in areas where they are being used.

⚠ DANGER

Hazardous Gases - Personal Protective Equipment (PPE) Required!

Refrigerant in the presence of an open flame, spark, or electrical short produces toxic gases that are severe respiratory irritants which can cause serious injury or possible death. When working with or around hazardous chemicals, ALWAYS refer to appropriate Material Data Safety Sheets (MSDS) and OSHA/GHS (Global Harmonized System of Classification and Labelling of Chemicals) guidelines for information on allowable personal exposure levels, proper respiratory protection, and handling instructions.

⚠ DANGER

Refrigerant Vapor Hazard!

Do not inhale refrigerant. Use caution when working with refrigerant or a refrigeration system in any confined area with a limited air supply. Refrigerant displaces air and can cause oxygen depletion, resulting in suffocation and possible death. When working with or around hazardous chemicals, ALWAYS refer to appropriate Material Data Safety Sheets (MSDS) and OSHA/GHS (Global Harmonized System of Classification and Labelling of Chemicals) guidelines for information on allowable personal exposure levels, proper respiratory protection, and handling instructions.

Safety Precautions

⚠ WARNING

Personal Protective Equipment (PPE) Required!

Refrigerant in a liquid state evaporates rapidly when exposed to the atmosphere, freezing anything it contacts. Wear butyl lined gloves and other clothing and eye wear when handling refrigerant to help prevent frostbite. When working with or around hazardous chemicals, ALWAYS refer to appropriate Material Data Safety Sheets (MSDS) and OSHA/GHS (Global Harmonized System of Classification and Labelling of Chemicals) guidelines for information on allowable personal exposure levels, proper respiratory protection, and handling instructions.

Refrigerant Oil

Observe the following precautions when working with or around refrigerant oil:

⚠ WARNING

Personal Protective Equipment (PPE) Required!

Protect your eyes from contact with refrigerant oil. The oil can cause serious eye injuries. Protect skin and clothing from prolonged or repeated contact with refrigerant oil. To prevent irritation, wash your hands and clothing thoroughly after handling the oil. Rubber gloves are recommended. When working with or around hazardous chemicals, ALWAYS refer to appropriate Material Data Safety Sheets (MSDS) and OSHA/GHS (Global Harmonized System of Classification and Labelling of Chemicals) guidelines for information on allowable personal exposure levels, proper respiratory protection, and handling instructions.

First Aid

REFRIGERANT

- **Eyes:** For contact with liquid, immediately flush eyes with large amounts of water and get prompt medical attention.
- **Skin:** Flush area with large amounts of warm water. Do not apply heat. Remove contaminated clothing and shoes. Wrap burns with dry, sterile, bulky dressing to protect from infection. Get prompt medical attention. Wash contaminated clothing before reuse.
- **Inhalation:** Move victim to fresh air and use Cardio Pulmonary Resuscitation (CPR) or mouth-to-mouth resuscitation to restore

breathing, if necessary. Stay with victim until emergency personnel arrive.

- **Frost Bite:** In the event of frost bite, the objectives of First Aid are to protect the frozen area from further injury, warm the affected area rapidly, and to maintain respiration.

REFRIGERANT OIL

- **Eyes:** Immediately flush with large amounts of water for at least 15 minutes. Get prompt medical attention.
- **Skin:** Remove contaminated clothing. Wash thoroughly with soap and water. Get medical attention if irritation persists.
- **Inhalation:** Move victim to fresh air and use Cardio Pulmonary Resuscitation (CPR) or mouth-to-mouth resuscitation to restore breathing, if necessary. Stay with victim until emergency personnel arrive.
- **Ingestion:** Do not induce vomiting. Immediately contact local poison control center or physician.

ENGINE COOLANT

- **Eyes:** Immediately flush with large amounts of water for at least 15 minutes. Get prompt medical attention.
- **Skin:** Remove contaminated clothing. Wash thoroughly with soap and water. Get medical attention if irritation persists.
- **Ingestion:** Do not induce vomiting. Immediately contact local poison control center or physician.

BATTERY ACID

- **Eyes:** Immediately flush with large amounts of water for at least 15 minutes. Get prompt medical attention. Wash skin with soap and water.
- **Skin:** Immediately remove contaminated clothing. Wash skin with large volumes of water, for at least 15 minutes. Wash skin with soap and water. Do not apply fatty compounds. Seek immediate medical assistance.
- **Inhalation:** Provide fresh air. Rinse mouth and nose with water. Seek immediate medical assistance.
- **Ingestion:** If the injured person is fully conscious: make the person drink extensive amounts of milk. Do not induce vomiting. Take the injured person immediately to a hospital.

ELECTRICAL SHOCK

Safety Precautions

Take **IMMEDIATE** action after a person has received an electrical shock. Get quick medical assistance, if possible.

The source of the shock must be quickly stopped, by either shutting off the power or removing the victim. If the power cannot be shut off, the wire should be cut with a non-conductive tool, such as a wood-handle axe or thickly insulated cable cutters. Rescuers should wear insulated gloves and safety glasses, and avoid looking at wires being cut. The ensuing flash can cause burns and blindness.

If the victim must be removed from a live circuit, pull the victim away with a non-conductive material. Use wood, rope, a belt or coat to pull or push the victim away from the current. **DO NOT TOUCH** the victim. You will receive a shock from current flowing through the victim's body. After separating the victim from power source, immediately check for signs of a pulse and respiration. If no pulse is present, start Cardio Pulmonary Resuscitation (CPR). If a pulse is present, respiration might be restored by using mouth-to-mouth resuscitation. Call for emergency medical assistance.

ASPHYXIATION

Move victim to fresh air and use Cardio Pulmonary Resuscitation (CPR) or mouth-to-mouth resuscitation to restore breathing, if necessary. Stay with victim until emergency personnel arrive.

Safety Decals and Locations

Condenser and Evaporator Fans

Be aware of the warning nameplates near the condenser fans and evaporator fans.

Figure 1. Fan Warning Nameplate



High Voltage Components

Various components on the Precedent unit operate using 220/3/60 or 460/3/60 high voltage and are identified by warning nameplates. All high voltage wiring is identified by ORANGE conduit. Be aware of the locations of these components. Only certified, trained technicians can service them.

Figure 2. High Voltage Nameplates

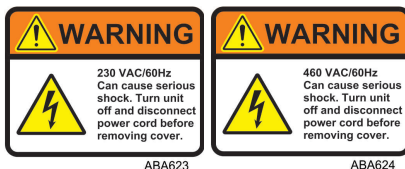

Figure 3. Ether Starting Aids Warning Nameplate (located near engine)



AMA1584

California Proposition 65 Warning Nameplate

Figure 4. P65 Warning Nameplate



RCS1032

Unit Description

Unit Overview

Thermo King Precedent multi-temperature refrigeration systems are designed to control temperatures in two or three compartments (zones). The system allows any compartment to be set at any temperature.

Precedent C-600M and S-610M host units are equipped with a single evaporator that controls temperature in one compartment (Zone 1), and a remote evaporator that controls temperature in another compartment (Zone 2). A unit with three zones has additional remote evaporator(s), which controls temperature in a third compartment (Zone 3).

Precedent DE host units are equipped with dual evaporators: one evaporator controls temperatures in one compartment (Zone 1), the other evaporator controls the temperature in another compartment (Zone 2). DE-3 host units utilize an additional remote evaporator which controls temperatures in a third compartment (Zone 3).

These units feature all-new DDE (Diesel Direct Electric) architecture with a quiet running Thermo King diesel engine and a Thermo King X-430 reciprocating compressor.

The units are available in the following models:

Standard: Cooling and heating on diesel engine operation.

SmartPower™ Option: Cooling and heating on diesel engine operation and electric standby operation.

Figure 5. Precedent Multi-Temperature Host Unit



Figure 6. Remote Evaporator (S-3 shown, S-2 similar)



Diesel Engine

The four cylinder engine is a water cooled, direct injection diesel engine. The engine is coupled directly to the compressor on standard units. A centrifugal clutch transfers power from the engine to the compressor on Smart Power units. Belts transmit power to the AC generator, water pump, and alternator. Refer to the Specifications section for additional engine information.

Extended Life Coolant (ELC)

ELC (Extended Life Coolant) is standard equipment. The maintenance interval for ELC is five years or 12,000 hours. A nameplate on the coolant expansion tank identifies units with ELC. The new engine coolant, Chevron Extended Life Coolant, is RED in color instead of the previous GREEN or BLUE-GREEN colored conventional coolants.

NOTICE

System Contamination!

Do not add "GREEN" or "BLUE-GREEN" conventional coolant to cooling systems using "RED" Extended Life Coolant, except in an emergency. If conventional coolant is added to Extended Life Coolant, the coolant must be changed after 2 years instead of 5 years.

Note: *The use of 50/50 percent pre-mixed Extended Life Coolant (ELC) is recommended to assure that de-ionized water is being used. If 100 percent full strength concentrate is used, de-ionized or distilled water is recommended over tap water to insure the integrity of the cooling system is maintained.*

EMI 3000

EMI 3000 is an extended maintenance interval package. The EMI 3000 package consists of the following key components:

- EMI 3000-Hour Cyclonic Air Cleaner Assembly and Air Cleaner Element
- EMI 3000-Hour 5-Micron Fuel Filter
- EMI 3000-Hour Dual Element Oil Filter (blue with white lettering)
- API Rating CJ-4 or CK-4 Oil
- Five Year or 12,000 Hour Extended Life Coolant (ELC)

The EMI package allows standard maintenance intervals to be extended to 3,000 hours, or 2 years, whichever occurs first.

Note: *Units equipped with the EMI 3000 package do require regular inspection in accordance with Thermo King's maintenance recommendations.*

Thermo King X430 Series Reciprocating Compressor

The unit is equipped with a Thermo King X430 Series four cylinder reciprocating compressor with 30.0 cu. in. (492 cm³) displacement.

Electronic Throttling Valve

The ETV provides enhanced control of the refrigeration system as follows:

- Allows the refrigeration system to fully utilize the power capabilities of the engine under varying conditions
- Provides an additional measure of protection against high discharge pressures
- Protects the engine from high coolant temperature shutdowns
- Provides a means of precise temperature control.

Remote Evaporators

Remote evaporators (if equipped) are mounted on the ceiling of each remote compartment to provide temperature control for Zone 2 and Zone 3 (if used).

SMART REEFER 4 (SR-4) Control System

CAUTION

Risk of Injury!

Do not operate the SR-4 Controller until you are completely familiar with its function.

The SR-4 is a microprocessor control system designed for a transport refrigeration system. The SR-4 integrates the following functions:

- Changing setpoint and operating mode
- Viewing gauge, sensor, and hourmeter readings
- Initiating Defrost cycles
- Viewing and clearing alarms

The microprocessor components are located inside the control box, which is located inside the lower roadside service door. The microprocessor is connected to a Human Machine Interface (HMI) Control Panel. It is used to operate the unit. The HMI control panel is mounted on the face of the control

box. It is clearly visible through an opening in the lower roadside service door.

See Operating Instructions for more information about the SR-4 Controller.

Depending on the air temperature in the trailer, as sensed by the microprocessor Base Controller, the unit will typically operate in one of the following modes:

Diesel Operation

In diesel operation, the microprocessor will select the operating mode from the following:

- High Speed Cool
- Low Speed Cool
- Low Speed Modulated Cool
- Null (CYCLE-SENTRY operation only)
- Low Speed Modulated Heat
- Low Speed Heat
- High Speed Heat
- Defrost

Electric Operation

In electric operation, the microprocessor will select the operating mode from the following:

- Cool
- Modulated Cool
- Null (CYCLE-SENTRY operation only)
- Modulated Heat (Hot Gas only)
- Hot Gas Heat
- Full Heat (Hot Gas and Electric Heat)
- Defrost (Hot Gas and Electric Heat)

CYCLE-SENTRY™ Start-Stop Controls

The CYCLE-SENTRY Start-Stop fuel saving system provides optimum operating economy.

Unit Description

WARNING

Risk of Injury!

The unit can start at any time without warning. Press the OFF key on the HMI control panel, place the unit On/Off switch in the Off position, and disconnect the battery before inspecting or servicing any part of the unit.

When CYCLE-SENTRY Mode is selected, the unit will start and stop automatically to maintain setpoint, keep the engine warm, and the battery charged. When Continuous Mode is selected, the unit starts automatically and runs continuously to maintain setpoint and provide constant airflow.

Note: *The SR-4 Controller provides a wide range of control and programming flexibility. However, pre-programming of the unit controller may prohibit operation in certain temperature ranges within some modes and may also prohibit certain modes of operation. Refer to the SR-4 Trailer Multi-Temperature Diagnostic Manual (TK 55788–2–OD) for information about controller programming.*

In CYCLE-SENTRY, if the block temperature falls below 30 F (-1 C), the engine will start and run until the block temperature is above 90 F (32 C). If the battery voltage falls to the programmed limit selected by CYCLE-SENTRY Battery Voltage (typically 12.2 volts) and Diesel CYCLE-SENTRY mode is selected, the engine will start and run until the charge rate falls below that programmed by CYCLE-SENTRY Amps (typically 5 amperes).

Features of the CYCLE-SENTRY system are:

- Offers either CYCLE-SENTRY or Continuous Run operation.
- Controller regulated all season temperature control.
- Maintains minimum engine temperature in low ambient conditions.
- Battery Sentry keeps batteries fully charged during unit operation.
- Variable preheat time.
- Preheat indicator buzzer.

Data Logging

There are two separate data loggers. The data is downloaded through the Flash Drive Only USB port on the front of the control box using a flash drive and ThermoServ™ software.

Figure 7. HMI Controller and USB Port

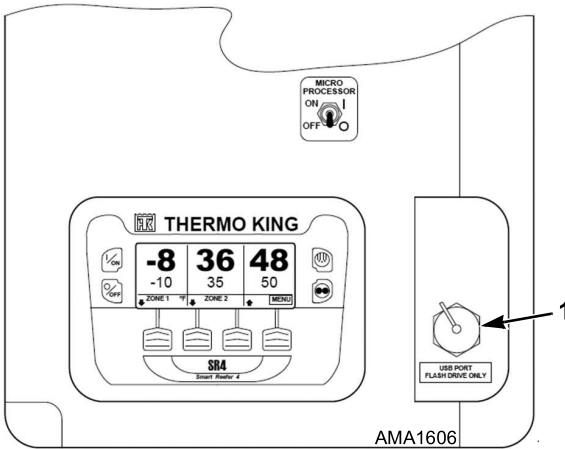

1.	Flash Drive Only USB Port
----	---------------------------

Flash Drive Only USB Port: Standard USB drives that have been programmed with ThermoServ can be used in the Flash Drive Only USB Port. Use of a USB drive eliminates the need for an on-site computer and does not require cables.

The Flash Drive Only USB port can be used to:

- Download the CargoWatch and ServiceWatch Data Loggers.
- Flashload the Base Controller and HMI Control Panel.

PC Only USB Port: The PC Only USB Port is a connector located on the base controller inside the control box. It is used to connect the controller to a PC with a standard USB to USB mini cable.

The PC Only USB port can be used to:

- Upload trailer ID and Unit Serial Number (For new units and if new controller is installed).
- Data Logger setup.
- Download the CargoWatch and ServiceWatch Data Loggers.
- Flashload the Base Controller and HMI Control Panel.

ServiceWatch™: ServiceWatch is standard equipment. It records operating events, alarm codes and compartment temperatures as they occur and at

Unit Description

preset intervals. This information is typically used to analyze unit performance.

CargoWatch™: CargoWatch data logging requires the installation of optional sensors. Up to six temperature sensor/probes and four door switches can be installed. CargoWatch also logs the setpoint. Use a USB port to download the CargoWatch data. If optional temperature sensors are installed, their readings are displayed as Datalogger Sensor (1-6) Temperature in the sensor readings.

OptiSet Plus™

OptiSet Plus is a group of programmable functions that control how the unit will operate with specific setpoints or named products. This assures that when a particular setpoint or named product is selected, the unit will always operate the same way. This allows an entire fleet to be configured to match customers' needs. Contact your Thermo King dealer for information about programming OptiSet Plus.

FreshSet™

FreshSet is included in OptiSet Plus. FreshSet is a demand base temperature control for fresh products. FreshSet modifies and adjusts unit airflow operation to control temperature and to maximize protection of cargo, while keeping operating costs to a minimum. Contact your Thermo King dealer for information about programming FreshSet.

ECO Pulldown Mode

This programmable feature allows the unit to operate in low speed during initial pulldown until the temperature in any one zone inside the trailer reaches 30F. At this point, it automatically switches the unit to high speed operation. For set points above 30F, the unit will operate in ECO Pulldown mode until set point is achieved, possibly never operating in high speed mode.

Operating the unit in low speed pulldown can save up to 15% fuel during the initial pulldown without significantly increasing the overall unit run time.

All Thermo King Multi-Temperature units come factory set with the ECO Pulldown Mode enabled. Contact your Thermo King dealer for further information about ECO Pulldown Mode.

Defrost

Frost gradually builds-up on evaporator coils as a result of normal operation. The unit uses hot refrigerant to defrost the evaporator coil. Hot refrigerant gas passes through the evaporator coil and melts the frost. The water flows through collection drain tubes onto the ground. The methods of defrost initiation are Automatic and Manual.

Automatic Defrost: The SR-4 automatically initiates timed or demand defrost cycles. The SR-4 microprocessor can be programmed to initiate timed defrost cycles at intervals of 2, 4, 6, 8, or 12 hours. Demand defrost cycles occur if the differences between the return air temperature, discharge air temperature, and coil temperature exceed certain limits. The unit can enter defrost cycles as often as every 30 minutes if required.

Precision Temperature Control (PTC)

When activated, PTC pulses the Liquid Line Solenoid (LSS) in the selected Zone as necessary to control the cooling capacity for more precise temperature control. PTC is only allowed in one remote zone and only for fresh setpoints. Contact your Thermo King dealer for information about programming PTC. PTC is not available on DE units.

Opening the Front Doors

To open the doors and access the engine compartment, pull the right door latch handle out at a 45 degree angle and turn it down (clockwise) 90 degrees ([Figure 8, p. 28](#)). To close the door, push the door closed while holding the door latch handle open and then turn it up (counterclockwise) 90 degrees.

THERMO KING

Unit Description

Figure 8. Door Latch Location



- | | |
|----|------------|
| 1. | Door Latch |
|----|------------|

Figure 9. Door Latch Nameplate

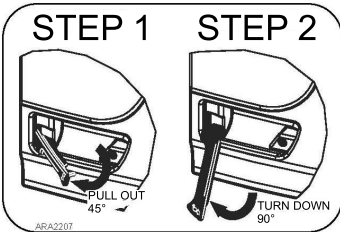

Engine Compartment Components

WARNING

Risk of Injury!

The unit can start at any time without warning. Press the OFF key on the HMI control panel, place the unit On/Off switch in the Off position, and disconnect the battery before inspecting or servicing any part of the unit.

▲ CAUTION

Service Procedures!

Turn the unit off before attempting to check the engine oil.

The following maintenance items can be checked visually.

Engine Oil Dipstick: Use the engine oil dipstick to check the engine oil level.

Unit Protection Devices

Coolant Level Switch: The coolant level switch closes if the coolant level drops below an acceptable level. If it stays closed for a specified time, the microprocessor records Alarm Code 37.

Engine Coolant Temperature Sensor: The microprocessor uses the engine coolant temperature sensor to monitor the engine coolant temperature. If the engine coolant temperature rises above an acceptable level, the microprocessor records Alarm Code 41 and possibly 18. The microprocessor might also shut the unit down.

Fuses: A number of fuses are used to protect various circuits and components.

Smart FETs: Smart FETs in the base controller protect circuits and components.

High Pressure Cutout Switch: The high pressure cutout switch is located on the compressor discharge manifold. If the compressor discharge pressure becomes excessive, the switch opens the circuit to the run relay to stop the unit. The microprocessor will record Alarm Code 10.

High Pressure Relief Valve: This valve is designed to relieve excessive pressure in the refrigeration system. It is located on the receiver tank. If the high pressure relief valve opens, much of the refrigerant will be lost. Take the unit to a Thermo King dealer if this occurs.

Low Oil Level Switch: The low oil level switch closes if the oil drops below an acceptable level. If it stays closed for a specified time, the microprocessor shuts the unit down and records Alarm Code 66.

Low Oil Pressure Switch: The low oil pressure switch closes if the oil pressure drops below an acceptable level. If it stays closed for a specified time, the microprocessor shuts the unit down and records Alarm Code 19.

Preheat Buzzer: The preheat buzzer sounds when the controller energizes the preheat relay. This warns anyone near the unit that the controller is about to start the engine.

Unit Description

Overload Relay-Automatic Reset (SmartPower Units): An overload relay protects the standby electric motor. The overload relay opens the circuit to the electric motor if the motor overloads for any reason (e.g., low line voltage or improper power supply) while the unit is on electric standby operation. The microprocessor will record Alarm Code 90.

Base Controller Fuses

Fuses located on the base controller protect various circuits and components. The base controller is located inside the control box.

Expansion Module Fuses

Fuses located on the expansion module protect various circuits and components.

ECU Interface Board Fuses

Fuses located on the expansion module protect various circuits and components.

Battery Fuses

A 100A fuse (FS2) protects the 2 circuit to the base controller.

A 70A fuse (FS2) protects the 2 circuit to the ECU.

A 70A fuse (FS3) protects the 2/8S circuit to the starter relay.

Manual Pretrip Inspection and Loading Procedures

The following Manual Pretrip Inspection should be completed before starting the unit and loading the trailer. While the pretrip inspection is not a substitute for regularly scheduled maintenance inspections, it is an important part of the preventive maintenance program designed to head off operating problems and breakdowns before they happen.

Fuel: The diesel fuel supply must be adequate to guarantee engine operation to the next check point.

Engine Oil: The engine oil level should be at the FULL mark with the dipstick turned (threaded) into oil pan. Never overfill.

⚠ CAUTION

Hazardous Pressures!

Do not remove expansion tank cap while coolant is hot.

NOTICE

System Contamination!

Do not add "GREEN" or "BLUE-GREEN" conventional coolant to cooling systems using "RED" Extended Life Coolant, except in an emergency. If conventional coolant is added to Extended Life Coolant, the coolant must be changed after 2 years instead of 5 years.

Coolant: The engine coolant must have antifreeze protection to -30 F (-34 C). Alarm Code 37 indicates low coolant. Add coolant in the expansion tank.

Battery: The terminals must be clean and tight.

Belts: The belts must be in good condition and adjusted to the proper tensions.

Electrical: The electrical connections should be securely fastened. The wires and terminals should be free of corrosion, cracks, or moisture.

Structural: Visually inspect the unit for leaks, loose or broken parts, and other damage. The condenser and evaporator coils should be clean and free of debris. Check the defrost drain hoses and fittings to make sure they are open. Verify all the doors are latched securely.

Coils: The condenser and evaporator coils must be clean and free of debris.



Manual Pretrip Inspection and Loading Procedures

Cargo Box: Check the interior and exterior of the cargo box for damage. Any damage to the walls or insulation must be repaired.

Cargo Doors: Verify the cargo doors and weather seals are in good condition. The doors should latch securely and the weather seals should fit tightly.

Defrost Drains: Check the defrost drain hoses to make sure they are open.

Operating Instructions

SMART REEFER 4 Multi-Temp (SR-4 MT) Control System

Thermo King has applied the latest advances in computer technology to develop a device that controls temperature and unit function, and displays operating information quickly and accurately.

There is nothing complicated about learning to operate the SR-4 MT Controller, but you will find that a few minutes studying the contents of this manual will be time well spent.

CAUTION

Risk of Injury!

Do not operate the SR-4 Controller until you are completely familiar with its function.

The microprocessor components are located inside the control box, which is located inside the lower roadside service door. The microprocessor is connected to a Human Machine Interface (HMI) Control Panel. It is used to operate the unit. The USB port is used to retrieve data from the data logging system.

Figure 10. SR-4 MT Control Panel With Service Door Open

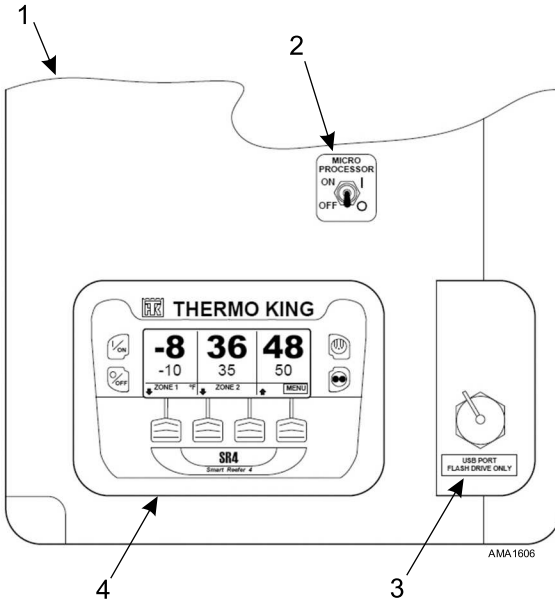

1.	Control Box	3.	Flash Drive Only USB Port
2.	Microprocessor On/Off Switch	4.	HMI Control Panel

Microprocessor On/Off Switch

This switch supplies or removes electrical power to the microprocessor. It is located above the HMI Control Panel. It is hidden when the lower roadside body panel surrounding the Control Box is closed.

SR-4 HMI Control Panel

⚠ WARNING

Risk of Injury!

The unit can start at any time without warning. Press the OFF key on the HMI control panel, place the unit On/Off switch in the Off position, and disconnect the battery before inspecting or servicing any part of the unit.

Use the HMI control panel to operate the unit.

The HMI control panel has a display and eight touch sensitive keys. The display is capable of showing both text and graphics. The four keys on the left and right sides of the display are “hard” (dedicated) keys. The four keys under the display are “soft” keys. The function of soft keys change depending on the operation being performed. If a soft key is active, its function will be shown in the display directly above the key.

Control Panel Display

The display is used to present unit information to the operator. This information can include setpoint and temperature for each zone, unit or zone operating information, gauge readings, temperatures, and other information as selected by the operator.

The default display is called the Standard Display (Figure 11, p. 35). It is described in detail later in this section.

Figure 11. Control Panel Display and Keys

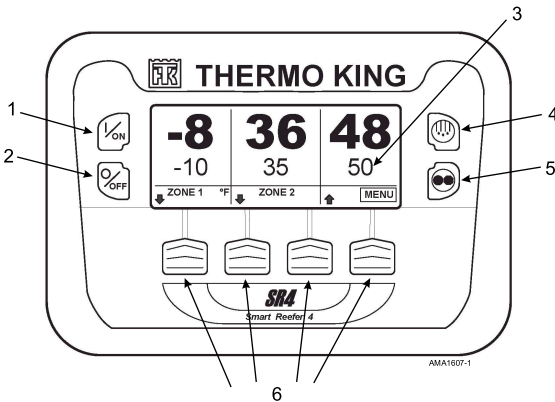
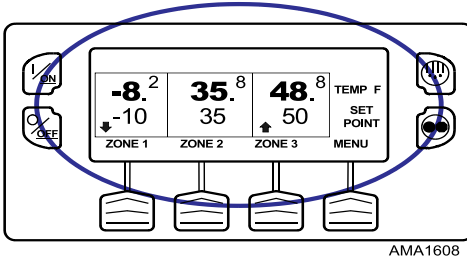

Figure 12. Display



The Standard Display of box temperature and setpoint for three zones is shown (Figure 12, p. 36). The unit is running in Continuous Mode. Zone 1 has a setpoint of -10°F, and a return air temperature of -8.2°F. The downward pointing arrow shows this zone is cooling. Zone 2 has a setpoint of 35°F, and a return air temperature of 35.8°F. The absence of an arrow indicates that this zone is in null. Zone 3 has a setpoint of 50°F, and a return air temperature of 48.8°F. The upward pointing arrow shows this zone is heating.

Note: The zone temperature shown is always return air temperature.

Pressing the soft key under each zone allows the setpoint for that zone to be changed. In addition, the soft keys under Zone 2 and Zone 3 are used to turn those zones on and off. Pressing the soft key under MENU accesses the MAIN MENU.

Note: Zone 1 is always on when the control system is powered up.

Display Icons

Display symbols or icons are used to indicate the following:

- If a zone is cooling, heating, or in null.
- If the unit is operating in Cycle Sentry or Continuous Mode.
- If unit level or zone level alarm conditions have occurred.

Zone Cooling, Heating, or Null

Arrows are used to indicate if a zone is cooling, heating, or in null.



Figure 13. Cooling, Heating, Null Arrows

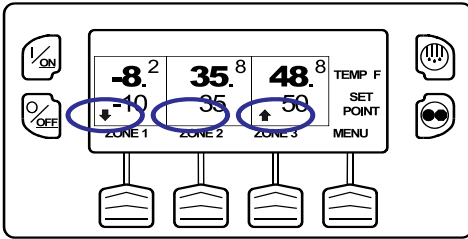

AMA1609



Arrows: (At the left side of the display) [Figure 13, p. 37](#) shows Zone 1 is cooling. If the arrow were pointing upward, Zone 1 would be heating. The absence of an arrow indicates that a Zone is in Null.



CYCLE SENTRY/Continuous Mode Key: If the Cycle Sentry Icon is present as shown ([Figure 14, p. 37](#)), the unit is operating in Cycle Sentry Mode. Absence of the Cycle Sentry Icon indicates the unit is operating in Continuous Mode.

If the Standard Display is shown, the Cycle Sentry Icon will appear in the upper right corner of the display as shown ([Figure 14, p. 37](#)).

Figure 14. Cycle Sentry Icon

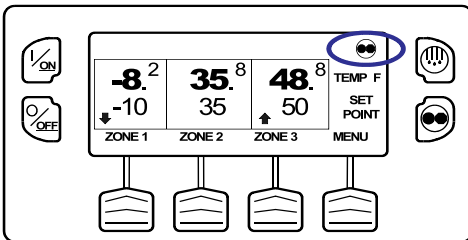

AMA1610

If the TemperatureWatch Display is shown, the Cycle Sentry Icon will appear in the lower part of the display as shown ([Figure 15, p. 38](#)).

Operating Instructions

Figure 15. Three Zone Temperature Watch Display - Unit in Cycle Sentry Mode

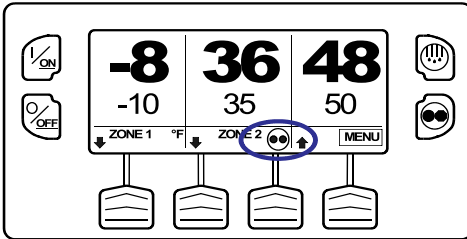

ECO Pulldown Mode

This programmable feature allows the unit to operate in low speed during initial pulldown until the temperature in any one zone inside the trailer reaches 30°F. At this point, it automatically switches the unit to high speed operation.

Operating the unit in low speed pulldown can save up to 15% fuel during the initial pulldown without significantly increasing the overall unit run time.

For set points above 30°F, the unit will operate in ECO Pulldown mode until set point is achieved, possibly never operating in high speed mode.

All Thermo King Multi-Temperature units come factory set with ECO Pulldown Mode enabled. When the Standard Display is shown, the ECO Pulldown icon will appear in the upper right corner of the display. Contact your Thermo King dealer for further information about ECO Pulldown Mode.

Figure 16. ECO Pulldown Mode Icon

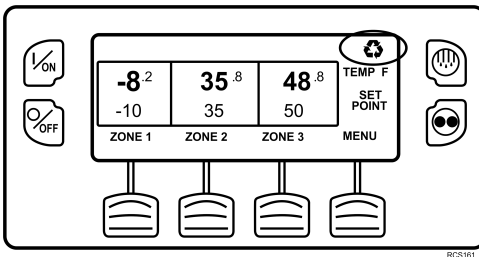

Zone Level or Unit Level Alarm Codes



Alarm Icon: The Alarm Icon is used to indicate the presence of one or more alarm codes. If the Alarm Icon is present, an alarm condition has occurred and an Alarm Code has been set. Absence of the Alarm Icon indicates no Check, Prevent or Shutdown Alarm Codes exist.

If a Zone Level (an alarm pertaining only to a particular zone) Alarm condition exists, the Alarm Icon will appear in the offending zone as shown (Figure 17, p. 39) (A Zone Level alarm exists in Zone 2).

Figure 17. Zone Level Alarm

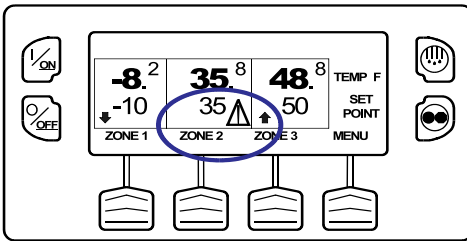

AMA1612

If a Unit Level (an alarm pertaining to the entire unit independent of zone) Alarm condition exists, the Alarm Icon will appear at the right side of the display as shown (Figure 18, p. 39).

Figure 18. Unit Level Alarm

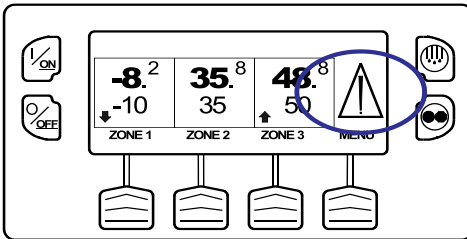

AMA1613

Hard Keys

The keys on either side of the display are dedicated or hard keys (Figure 19, p. 40). Their function always remains the same.

THERMO KING

Operating Instructions

Figure 19. Hard Keys

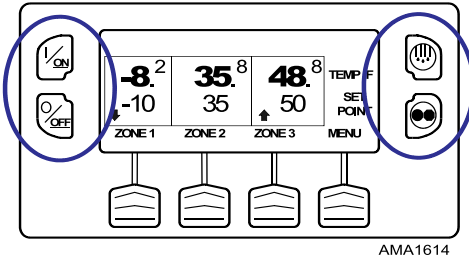

AMA1614



On Key: Used to turn the unit on. First the display will briefly show the Thermo King Logo and then the statement "Configuring System - Please Wait". When the power-up sequence is complete, the display shows the Standard Display of box temperature and setpoint. For more information see "Turning the Unit On and Off".



Off Key: Used to turn the unit off. First, the display will briefly show "System is Powering Down - Please Wait. Press On to Resume" and then "Off" will appear momentarily. When the power-down sequence is complete the display will be blank. For more information see "Turning the Unit On and Off".



Defrost Key: Press this key to initiate a Manual Defrost cycle. For more information see "Initiating a Manual Defrost Cycle".



CYCLE SENTRY: Used to select Cycle Sentry Mode or Continuous Mode operation. For more information see "Selecting Cycle Sentry or Continuous Mode".

Important: If the Hard Keys are illuminated, the HMI Control Panel is powered up even if the display is off. Typically, this indicates the CargoWatch Data Logger is active even when the unit is turned off.

Soft Keys

Figure 20. Soft Keys

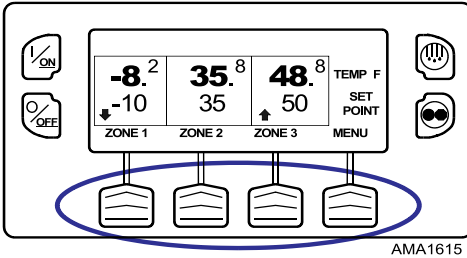

The four soft keys under the display are multi-purpose keys (Figure 20, p. 41). Their function changes depending on the operation being performed. If a soft key is active, the key function is shown in the display directly above the key. The keys are numbered from left to right, with Key 1 on the far left and Key 4 on the far right.

Typical soft key applications:

- ZONE ON/OFF and SETPOINT CHANGE
- MENU
- NEXT
- + OR -
- SELECT
- CLEAR
- HOURMETERS
- GAUGES
- BACK
- NO
- SENSORS
- EXIT
- HELP

Turning The Unit On And Off

The unit is turned on by pressing the ON Key (Figure 21, p. 42) and off by pressing the OFF Key. When the On Key is pressed the display briefly shows the THERMO KING Logo as the display initializes.

Important: The ON Key must be held down until the Thermo King Logo appears. If the ON Key is not held down long enough (approximately 1/2 second), the display may flicker but the unit will not start up. If this occurs, hold the ON Key down until the Thermo King logo appears.

Operating Instructions

Note: With Multi-Temp applications, Zone 1 is turned on any time the host unit is turned on. Zone 1 is turned off when the host unit is turned off.

Note: With extremely cold ambient temperatures, it may take up to 15 seconds for the display to appear on initial startup.

Figure 21. ON Key

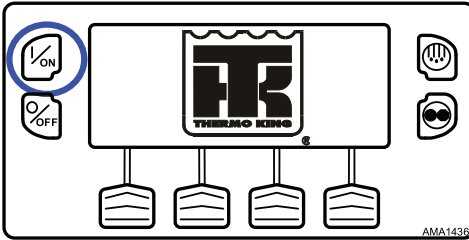

The startup screen appears while communications are established and the unit prepares for operation.

Figure 22. Startup Screen

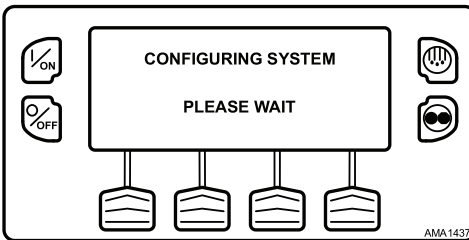

When the unit is ready to run, the Standard Display appears. The Two Zone display is shown (Figure 23, p. 42).

Figure 23. Two Zone Display

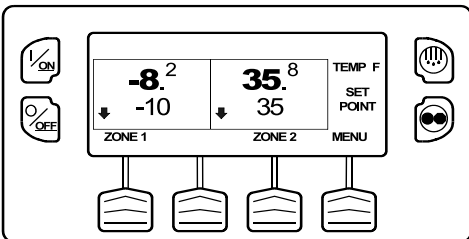

Pressing the OFF hard key stops unit operation. The controller shuts down immediately and the display briefly shows the power down message as shown (Figure 24, p. 43).

Figure 24. Power Down Message

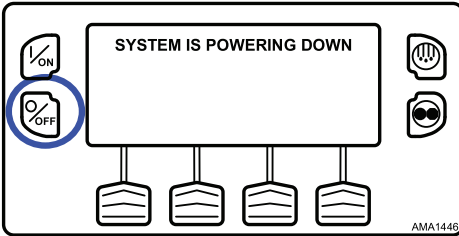

The display briefly shows OFF (Figure 25, p. 43) and then goes blank. To start the unit again, press the ON hard key.

Figure 25. Display Shows OFF

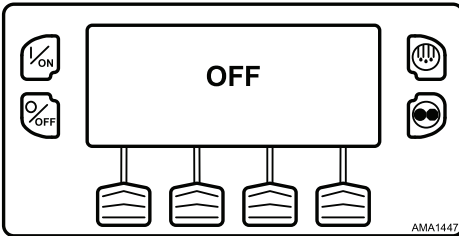

Two Zone Standard Display

Note: Fahrenheit is shown, Celsius display is similar.

The Standard Display is the default display that appears if no other display function is selected. The Two Zone Standard Display shows the return air temperature and setpoint for two zones. The absence of the Cycle Sentry Icon at the top of the display shows that the unit is operating in Continuous Mode. The return air temperature for Zone 1 is -8.2°F with a -10°F setpoint. The down-pointing arrow indicates that Zone 1 is cooling. The return air temperature for Zone 2 is 35.8°F with a 35°F setpoint. The down-pointing arrow indicates that Zone 2 is also cooling. The soft key under each zone allows the setpoint for that zone to be changed. In addition, the soft key under Zone 2 is used to turn that zone on and off. The soft key labeled MENU allows the Main Menu to be selected.

THERMO KING
Operating Instructions

Figure 26. Two Zone Standard Display

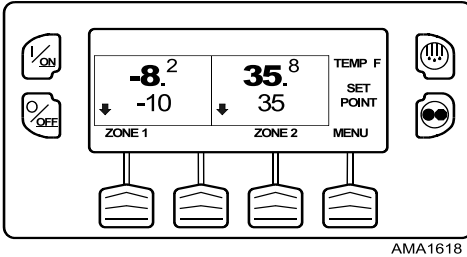

Three Zone Standard Display

Note: Fahrenheit is shown, Celsius display is similar.

The Three Zone Standard Display adds a third zone and functions the same way as the Two Zone Standard Display, but with another temperature controlled zone. The absence of the Cycle Sentry Icon at the top of the display (Figure 27, p. 44) shows that the unit is operating in Continuous Mode. The return air temperature for Zone 1 is -8.2°F with a -10°F setpoint. The down-pointing arrow indicates that Zone 1 is cooling. The return air temperature for Zone 2 is 35.8°F with a 35°F setpoint. The absence of the Up or Down pointing arrow indicates that Zone 2 is in Null. The return air temperature for Zone 3 is 48.8°F with a 50°F setpoint. The up-pointing arrow indicates that Zone 3 is heating. The soft key under each zone allows the setpoint for that zone to be changed. In addition, the soft keys under Zone 2 and Zone 3 are used to turn those zones on and off. The soft key labeled MENU allows the Main Menu to be selected.

Figure 27. Three Zone Standard Display

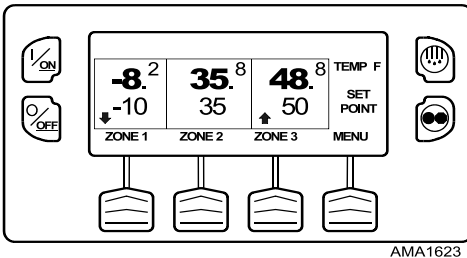

Single Zone Control Standard Display

This feature, if enabled in Guarded Access, allows Single Zone Control operation to be selected by choosing the Main Menu and then selecting Single Zone Control from the Mode Submenu. When this feature is selected, all zones will be forced on and will control to the same selected setpoint. The Single Zone Control Standard Display (Figure 28, p. 45) functions the same way as the other Standard Displays. The absence of the Cycle Sentry Icon at the top of the display shows that the unit is operating in Continuous mode. The box temperature for all zones is 35.8°F and all zones are controlling to a 35°F setpoint. The down-pointing arrow indicates that all zones are cooling. The soft key labeled Setpoint allows the setpoint for all zones to be changed. The soft key labeled Menu allows the Main Menu to be selected.

Figure 28. Single Zone Control Standard Display

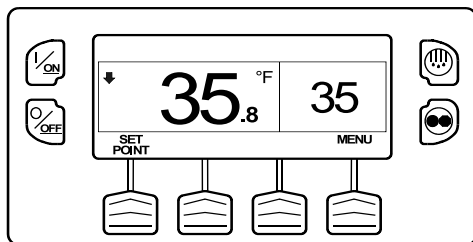

AMA1624

Operating the Unit in Single Zone Control Mode

The following differences exist when operating the unit in Single Zone Control Mode:

- Single Zone Control Mode will appear in the Mode Menu only if the Single Zone Control feature has been enabled in the Guarded Access/ Main Menu Configuration Menu. If the feature is enabled, Single Zone Control will appear in the Main Menu/Mode Menu.
- If Single Zone Control operation is selected, all zones will be forced on and will control to the same setpoint. The Zone 1 sensors are used to determine box temperature. All dividing wall(s) should be repositioned to create one large compartment. With the exception of defrost, the operating mode of each zone evaporator(s) will be the same when in this mode. Unit control is based on the temperature sensors of Zone 1.
- If Single Zone Control operation is selected, the Single Zone Standard Display provides only one soft key labeled Set Point. This allows the setpoint for all zones to be changed simultaneously.

Operating Instructions

- If Single Zone Control operation is selected, the individual zones cannot be turned off. The unit and all zones are turned On and Off simultaneously using the On and Off hard keys at the left side of the display.

The TemperatureWatch™ Display

The TemperatureWatch Display appears 2 ½ minutes after the Standard Display appears so long as there is no key activity and no Check, Prevent, or Shutdown alarms present. The TemperatureWatch Display (Figure 29, p. 46) will remain on until any key is pressed or a Check, Prevent, or Shutdown alarm occurs.

The TemperatureWatch Display shows the return air temperature and setpoint for each zone. Tenths of a degree are not shown by the TemperatureWatch display. The large numbers allow unit conditions to be checked from a distance. Pressing any soft key returns the display to the Standard Display.

Figure 29. Two Zone TemperatureWatch Display

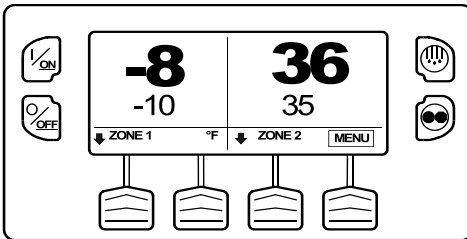

If an alarm condition (other than a Log Alarm) is present, the TemperatureWatch Display will not appear. If an alarm condition occurs while the TemperatureWatch Display is present, the display will return to the Standard Display.

If the Defrost Key or Cycle Sentry Key is pressed, the display will return to the TemperatureWatch Display immediately after the defrost cycle is initiated or the operating mode is changed.

In the Three Zone TemperatureWatch display, the Menu soft key label covers the Zone 3 label as shown (Figure 30, p. 47).

Figure 30. Three Zone TemperatureWatch Display

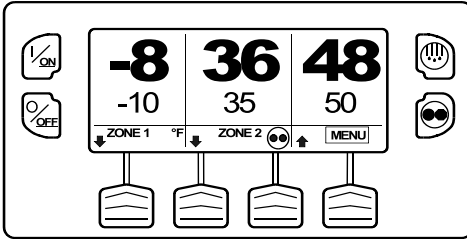

AMA1626

If the unit is operating in Cycle Sentry Mode, the Cycle Sentry icon will appear near Zone 2 as shown. If the unit is operating in Continuous Mode, the Cycle Sentry icon will not be present.

Changing the Setpoint

If the TemperatureWatch display is shown, press any soft key to return to the Standard Display. From the Standard Display, press the ZONE soft key for the desired zone. Zone 1 is shown (Figure 31, p. 47).

Figure 31. Zone 1

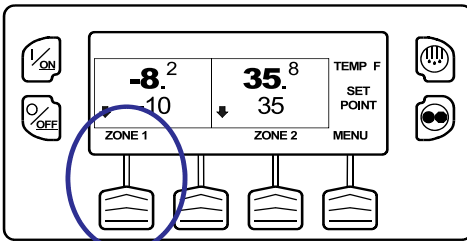

AMA1627

The setpoint display appears as shown (Figure 32, p. 48).

Figure 32. Setpoint Display

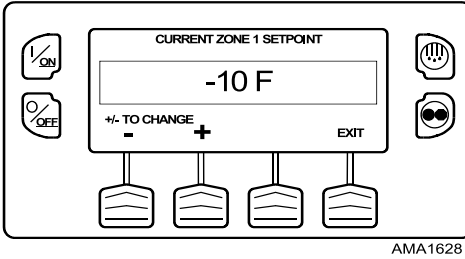

The “-” and “+” soft keys are used to increase or decrease the setpoint until the desired setpoint is shown. The setpoint has been changed to 0°F using the “+” soft key as shown (Figure 33, p. 48).

Figure 33. Setpoint Changed

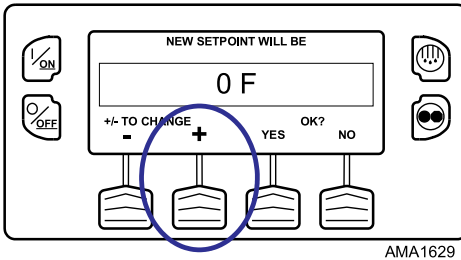

The YES and NO soft keys confirm the setpoint change (Figure 34, p. 49). When the desired setpoint has been selected using the “+” and/or “-” soft keys, press the YES soft key to confirm and load the new setpoint. If the setpoint is changed using the “+” or “-” soft keys, the change must be confirmed or rejected by pressing the YES or NO soft key within 10 seconds of changing the setpoint. A warning beep will sound after five seconds as a reminder. Failure to confirm the new setpoint by pressing YES or NO within 10 seconds of changing the setpoint will result in no setpoint change. If the setpoint is not confirmed, Alarm Code 127 Setpoint Not Entered is set, to indicate that the setpoint change was not completed.

Figure 34. YES and NO Keys

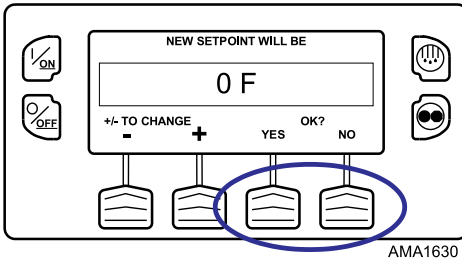

After the YES soft key has been pressed, the display will briefly show PROGRAMMING NEW SETPOINT - PLEASE WAIT. The display then confirms the new setpoint for two seconds (Figure 35, p. 49).

Figure 35. New Setpoint Confirmation

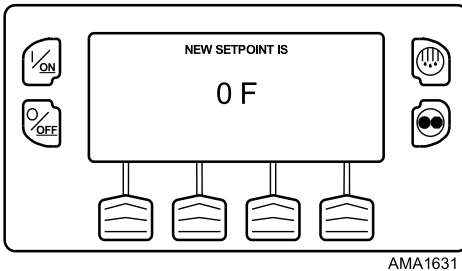

If the NO soft key is pressed, the display will briefly show SETPOINT NOT CHANGED and return to the Standard Display. The Standard Display will show the old setpoint.

Figure 36. Standard Display, New Setpoint

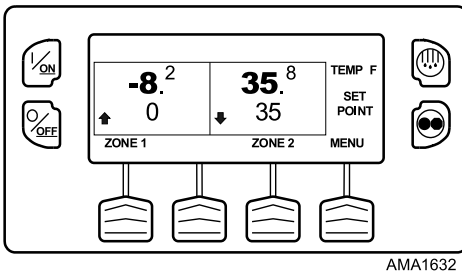

Operating Instructions

The display then returns to the Standard Display showing the new setpoint. The Zone 1 arrow now points up, to indicate that Zone 1 is heating.

Important: If the setpoint is changed using the "+" or "-" soft keys, the change must be confirmed or rejected by pressing the YES or NO soft key within 10 seconds of changing the setpoint.

- If the YES soft key is pressed, the setpoint change made with the "+" or "-" soft key is accepted, the setpoint changes, and the display returns to the Standard Display.
- If the NO soft key is pressed the setpoint change made with the "+" or "-" soft key is not accepted, the setpoint is not changed, and the display returns to the Setpoint Display.
- If the YES or NO soft key is not pressed within 10 seconds of making a change with the "+" or "-" soft key, the setpoint is not changed and the display returns to the Setpoint Display. The display briefly shows [SETPPOINT NOT CHANGED] and Alarm Code 127 Setpoint Not Entered is set, to indicate that the setpoint change was started but not completed.

Turning a Zone On and Off

Zone 1 will always be turned on any time the unit is turned on. Zone 2 and Zone 3 (if present) can be turned on and off as desired.

The state of each zone is retained when the unit is turned off and on. For example, on a three zone unit if Zone 2 is turned off and Zone 3 is turned on and the unit is turned off, the zone states remain as they were. When the unit is turned back on Zone 2 will still be off and Zone 3 will still be on.

To turn Zone 2 or Zone 3 on or off, press the soft key under the desired zone. Zone 2 is selected (Figure 37, p. 50).

Figure 37. Zone 2 Selected

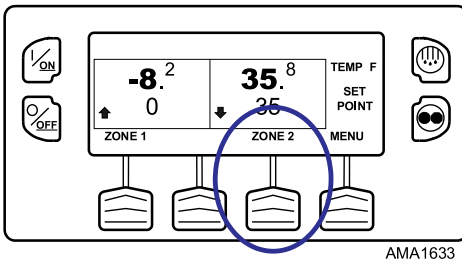

The Zone 2 setpoint display appears as shown (Figure 38, p. 51). If the zone is turned on, the third soft key will be labeled TURN ZONE OFF. If the zone is turned off, the third soft key will be labeled TURN ZONE ON. In this case TURN ZONE OFF is shown.

Figure 38. Zone 2 Setpoint Display

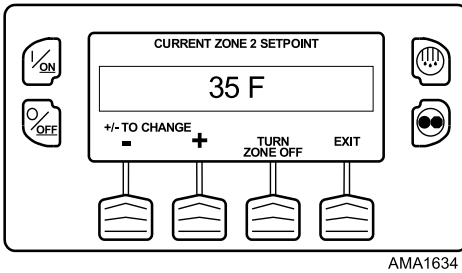

Press the TURN ZONE OFF soft key to turn the zone off (Figure 39, p. 51).

Figure 39. TURN ZONE OFF soft key

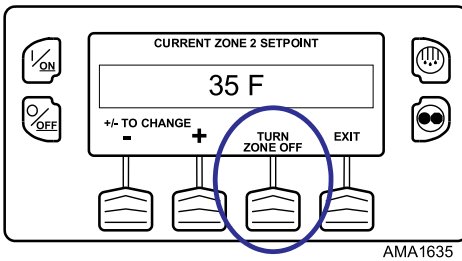

The display briefly shows PROGRAMMING ZONE ON/OFF - PLEASE WAIT. The display then confirms the new Zone 2 setting for several seconds (Figure 40, p. 52).

Operating Instructions

Figure 40. New Zone 2 Setting

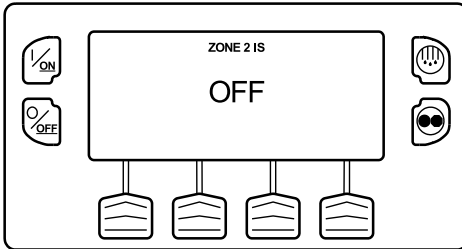

AMA1636

The display returns to the Standard Display showing Zone 2 is off. The setpoint for Zone 2 has been replaced with OFF as shown (Figure 41, p. 52) to indicate that the zone is now off.

Figure 41. Zone Off

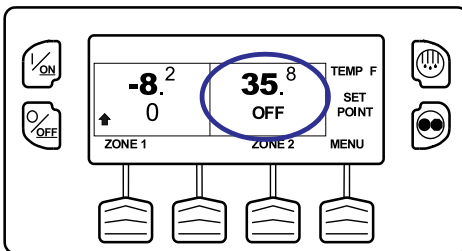

AMA1637

Starting the Diesel Engine

Diesel engine preheats and starts are automatic in both Continuous Mode and Cycle Sentry Mode. The engine will preheat and start as required when the unit is turned on. The engine preheat and start will be delayed in Cycle Sentry mode if there is no current need for the engine to run. If any keys are being pressed on the HMI Control Panel, the engine will not preheat and start until 10 seconds after the last key is pressed.

Note: *If the unit is equipped with optional Electric Standby there may be some additional prompts before the engine will start. Refer to "Starting the Electric Motor" for details.*

⚠ CAUTION

Risk of Injury!

The engine may start automatically any time the unit is turned on.

NOTICE

Equipment Damage!

Never use starting fluid. Damage to the engine can occur.

When the engine is preparing to start, the HMI Control Panel will display the engine start screen as shown (Figure 42, p. 53). The preheat buzzer sounds during the engine preheat and crank sequence.

Figure 42. Engine Start Screen

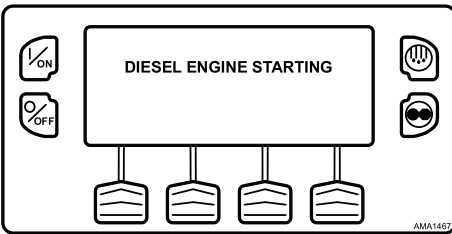

After the engine is started, the display returns to the Standard Display of temperature and setpoint.

Starting the Electric Motor

⚠ CAUTION

Risk of Injury!

The motor may start automatically any time the unit is turned on.

Note: Units equipped with the SmartPower option only.

Electric Power Receptacle: The electric power receptacle is used to connect the unit to an appropriate electric power source for electric standby operation (Figure 43, p. 54). The electric power receptacle is located next to the HMI Control Panel. Verify the unit and the power supply are turned off before connecting or disconnecting a power cord.

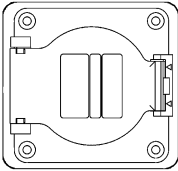
Figure 43. Electric Power Receptacle

Electric motor starting is automatic in both Continuous Mode and Cycle Sentry Mode. The motor will start as required when the unit is turned on. If any keys are being pressed on the HMI Control Panel prior to the motor start, the motor start will be delayed until 10 seconds after the last key is pressed.

When the motor is preparing to start, the HMI Control Panel will display the motor start screen (Figure 44, p. 54). The preheat buzzer sounds for 20 seconds before the electric motor starts.

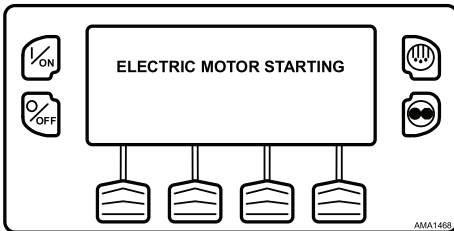
Figure 44. Motor Start Screen

After the motor is started the display returns to the Standard Display of temperature and setpoint.

Switching from Diesel to Electric

Note: Units equipped with the SmartPower option only.

If the Diesel to Electric Auto-Switch Enabled feature in Guarded Access is set YES, the unit will automatically switch to Electric Mode operation when standby power is connected and available.

If the Diesel to Electric Auto-Switch Enabled feature in Guarded Access is set NO, the prompt screen (Figure 45, p. 55) will appear when standby power is connected and available.

Figure 45. Standby Power Connected

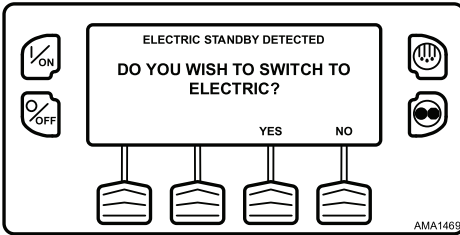

If NO is selected, the unit will continue to operate in Diesel Mode. If YES is selected, the display will briefly show the screen (Figure 46, p. 55).

Figure 46. YES Selected

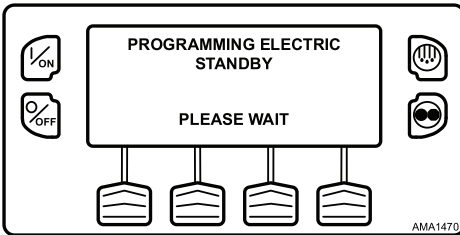

Electric Mode operation will briefly be confirmed. If unit operation is required the electric motor will start as shown previously under STARTING THE ELECTRIC MOTOR.

If the Diesel to Electric Auto-Switch Enabled feature in Guarded Access is set NO, the unit can also be switched from Diesel mode to Electric mode operation using the Electric Standby Selection from the Main Menu as shown later in this section.

Switching from Electric to Diesel

Note: Units equipped with the SmartPower option only.

If the Electric to Diesel Auto-Switch Enabled feature in Guarded Access is set YES, the unit will automatically switch to Diesel Mode operation when standby power is turned off or is no longer available.

If the Electric to Diesel Auto-Switch Enabled feature in Guarded Access is set NO and standby power is disconnected or fails, the unit will not automatically switch to Diesel mode. This is primarily designed to prevent

Operating Instructions

unauthorized diesel engine starts when the truck is indoors or on a ferry where engine operation is strictly prohibited. If the Electric to Diesel Auto-Switch Enabled feature in Guarded Access is set NO, the prompt screen (Figure 47, p. 56) will appear when standby power is turned off or is no longer available.

Figure 47. Standby Power is Off

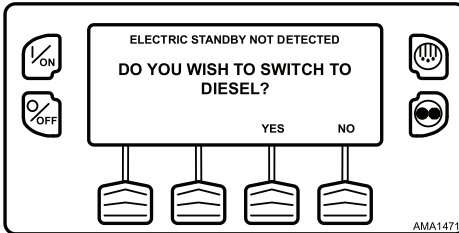

If YES is selected, the display will briefly show the screen (Figure 48, p. 56).

Figure 48. Yes Selected

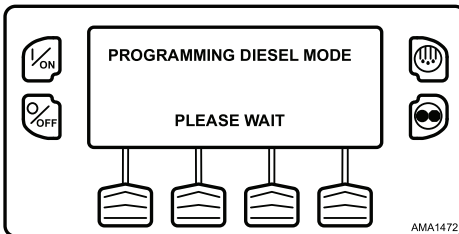

Diesel Mode operation will briefly be confirmed. If unit operation is required, the diesel engine will start as shown previously under “Starting the Diesel Engine”.

If the Electric to Diesel Auto-Switch Enabled feature in Guarded Access is set NO, the unit can also be switched from Diesel mode to Electric mode operation using the Diesel Selection from the Main Menu as shown later in this section.

Initiating a Manual Defrost Cycle

Defrost cycles are usually initiated automatically based on time or demand. Manual defrost is also available.

Manual defrost is only available if the zone is running and the zone evaporator coil temperature is less than or equal to 45°F (7°C). Other features such as door switch settings may not allow manual defrost under some conditions.

Note: *If the Rail Alternate feature is set YES, defrost is allowed with an evaporator coil temperature less than or equal to 55°F (13°C).*

To initiate a manual defrost cycle, press the Defrost Key as shown (Figure 49, p. 57).

Figure 49. Defrost Key

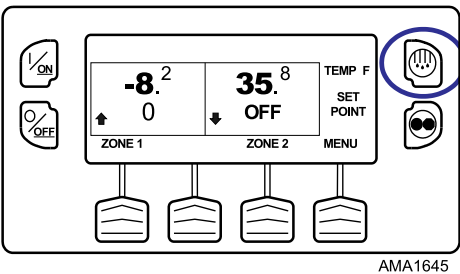

AMA1645

The display will briefly show [DEFROST]. Then the Zone Select display appears. Zone 1 selected is shown (Figure 50, p. 57).

Figure 50. Zone 1 Selected

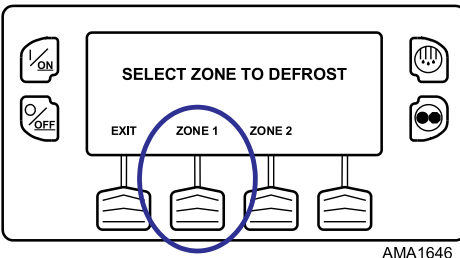

AMA1646

The display briefly shows [DEFROST], [PROGRAMMING DEFROST - PLEASE WAIT] and then [DEFROST STARTED] (Figure 51, p. 58).

Figure 51. Defrost Started

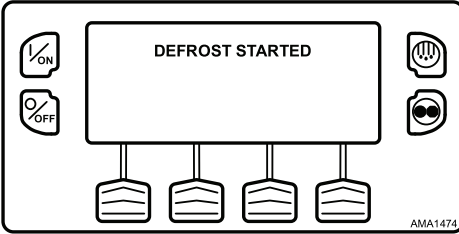

The display then shows the Defrost display. The bar indicator shows approximately the percentage of time remaining to complete the defrost cycle. The bar indicator (Figure 52, p. 58) shows that the Zone 1 defrost cycle is approximately 25% complete.

Figure 52. Bar Indicator

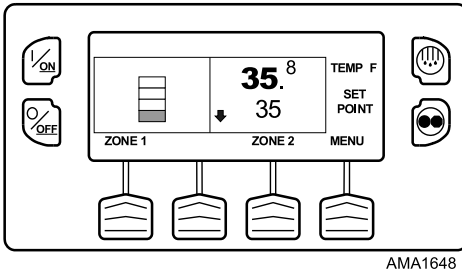

If conditions do not allow a defrost cycle, the display shown (Figure 53, p. 58) will briefly appear. The display will then return to the Standard Display.

Figure 53. Defrost Not Available

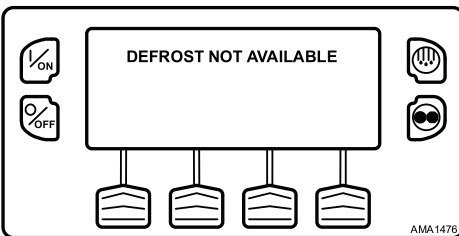

See summary of "Initiating a Manual Defrost Cycle" displays ().

Terminating a Defrost Cycle

The defrost cycle terminates automatically when the coil temperature is greater than or equal to 58°F (14°C) or the defrost timer expires. Defrost can also be terminated by turning the unit off and back on.

Note: *If Rail Alternate is set YES, the defrost cycle terminates at 70°F (21°C) or if the defrost timer expires.*

Selecting Cycle Sentry or Continuous Mode

When Cycle Sentry Mode is selected, the unit will start and stop automatically to maintain setpoint, keep the engine warm, and the battery charged. When Continuous Mode is selected, the unit starts automatically and runs continuously to maintain setpoint and provide constant airflow. The Cycle Sentry/Continuous selection affects all zones.



If the unit is operating in Cycle Sentry Mode, the Cycle Sentry Icon will appear in the display.

- The Cycle Sentry Icon appears in the upper right corner of the Standard Display (Figure 57, p. 61).
- The Cycle Sentry Icon appears in the lower right of the TemperatureWatch Display (Figure 58, p. 61).
- If the Cycle Sentry Icon is not shown, the unit is operating in Continuous Mode.

Note: *Cycle Sentry or Continuous Mode operation can also be selected from the Main Menu > Mode Menu.*

Operating Instructions

Cycle Sentry or Continuous Mode is selected by pressing the Cycle Sentry/Continuous Key (Figure 54, p. 60). The unit is currently operating in Continuous Mode as shown by the absence of the Cycle Sentry Icon.

Figure 54. Cycle Sentry/Continuous Key

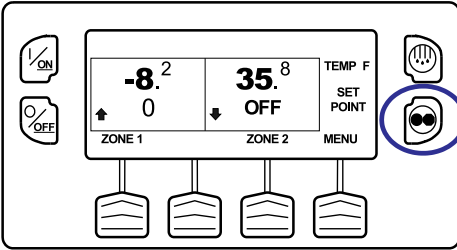

AMA1649

If the unit is operating in Continuous Mode, pressing the Cycle Sentry/Continuous Key changes the mode from Continuous Mode to Cycle Sentry Mode. The display confirms the change, as shown (Figure 55, p. 60).

Figure 55. Mode Change Confirmed

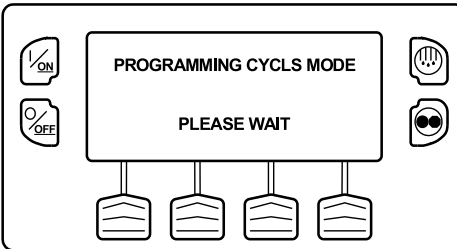

AMA1650

The new mode is confirmed for two seconds (Figure 56, p. 61).

Figure 56. Mode Confirmed

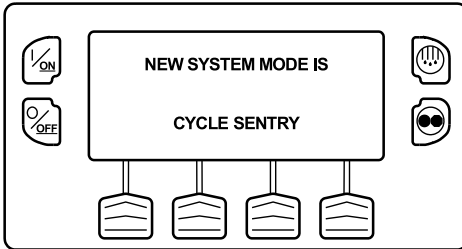

AMA1651

The display then returns to the Standard Display. In the example here, the unit is running in Cycle Sentry Mode as shown by the presence of the Cycle Sentry Icon at the upper right corner of the display (Figure 57, p. 61).

Figure 57. Cycle Sentry Icon, Upper Right Corner

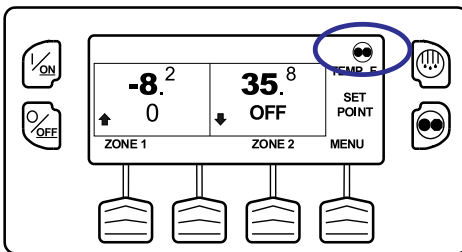

AMA1652

When the TemperatureWatch Display is shown, the Cycle Sentry Icon appears in the lower right corner (Figure 58, p. 61).

Figure 58. Cycle Sentry Icon, Lower Right Corner

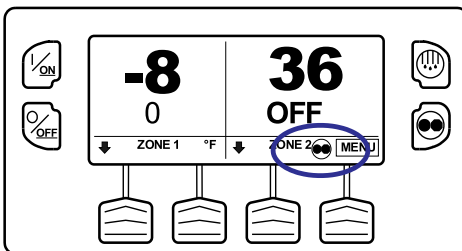

AMA1653

Operating Instructions

Pressing the Cycle Sentry/Continuous key again allows the operator to change back to Continuous Mode operation.

Important: *If the unit is in Cycle Sentry null and the mode is switched to Continuous Mode, the unit will start automatically.*

See summary of “Selecting Cycle Sentry or Continuous Mode” displays ().

Using the Main Menu

The Main Menu contains submenus that allow the operator to view information and modify unit operation. To access the Main Menu press the MENU soft key (Figure 59, p. 62).

Figure 59. MENU Soft Key

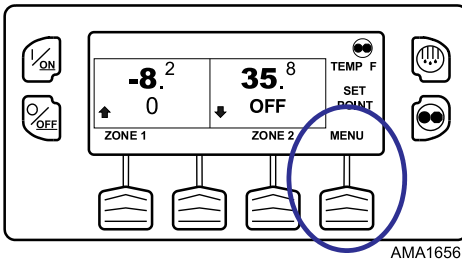

The first Main Menu choice will appear. Press and hold the UP and DOWN Keys to scroll thru the menu choices (Figure 60, p. 62). When the desired selection is shown on the display, press the SELECT Key to access it. The Pretrip Submenu is shown.

Figure 60. Pretrip Submenu

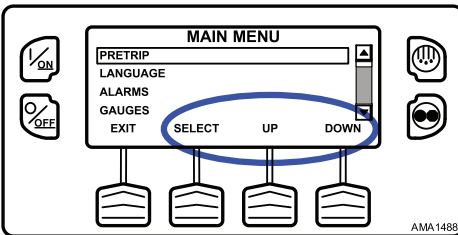

Main Menu Choices

Each of these Main Menu choices will be explained later in this section:

Pretrip: A Pretrip Test verifies unit operation.

Flash Drive: If a properly configured USB Flash Drive is currently connected to the USB Port on the unit Control Panel, the Flash Drive Menu will appear as a Main Menu selection.

Languages: If more than one language is enabled from the Guarded Access > Language Menu, this menu item will appear.

Alarms: The Alarm Menu allows the operator to view any active alarms, and allows most alarms to be cleared.

Gauges: The Gauges Menu allows the operator to view the unit gauges and I/O conditions.

Sensors: The Sensors Menu allows the operator to view the unit and CargoWatch Data Logger temperature sensors.

Data Logger (CargoWatch): The CargoWatch Data Logger is physically located in the HMI Control Panel. It can support up to 6 optional temperature sensors.

Hourmeters: The Hourmeters Menu allows the operator to view the unit hourmeters that have the view feature enabled in the Guarded Access menu.

Mode: The Mode Menu allows the operator to change the unit operating modes that have been enabled in Guarded Access.

Keypad Lockout: If enabled in Guarded Access > Main Menu Configuration, the keypad can be locked to prevent unauthorized use.

Start Sleep Mode: If this feature enabled in Guarded Access > Main Menu Configuration, the operator can select and set Sleep Mode from the Mode Menu.

SmartPower™ Electric Standby Option: The Diesel/Electric Standby selection from the Main Menu allows the operator to manually select diesel or electric mode operation on units equipped with the electric standby SmartPower option.

Adjust Brightness: The brightness of the HMI Control Panel display can be adjusted to allow for changing ambient light conditions.

Time: The Time and Date held by the HMI Control Panel can be checked. Time and Date cannot be changed from the Main Menu.

Clear All ECU Faults: Pressing this key will clear all existing Engine Control Unit (ECU) Fault Codes on applicable units with an ECU.

Fuel Usage: On unit's with an ECU, the engine provides fuel usage (fuel rate, total fuel used) information that can be used to give the operators fuel usage values for various scenarios and over specific durations.

Operating Instructions

Prime Fuel System: This function runs the fuel pump for up to five minutes to prime the fuel lines. Fuel priming is always shown on the HMI, but the functionality will only be available if the engine/electric motor is not running.

Flashload: The HMI will remind the user of a pending flashload at REB with the help of this screen.

Pretrip

Pretrip Test verifies unit operation. This display allows a Pretrip Test to be selected and initiated by the operator. If the Pretrip Test is entered with the unit not running, a Full Pretrip Test with device amp checks will be performed. If the Pretrip Test is entered with the unit running in either diesel or electric mode a Running Pretrip Test is performed. Test results are reported as PASS, CHECK, or FAIL when the Pretrip Test is completed.

Pretrip Test Conditions

- Current unit settings are saved and restored at the end of the Pretrip Test or if the unit is turned off and back on.
- Pretrip Test can be run in either Diesel or Electric Mode.
- The unit will auto switch from Diesel Mode to Electric Mode or from Electric Mode to Diesel Mode during a Pretrip Test if these features are enabled and the auto switch conditions occur.

Conditions Where Pretrip Tests Are Not Allowed

- If any shutdown alarms are present. Pretrip tests are allowed with some Check and Log alarms.
- If the unit is in Sleep Mode.
- If the unit is in Service Test Mode, Output Test Mode, or Evacuation Mode.

Pretrip Test Considerations

When performing a Pretrip Test, the following issues should be considered:

- If running a Pretrip Test on a trailer loaded with dry cargo, insure that proper airflow can occur around the load. If the load restricts airflow, false test results may occur. Also, these units have high refrigeration capacity which results in rapid temperature changes. Sensitive dry cargo may be damaged as a result.
- If running a Pretrip Test on a trailer that has just been washed down, the extremely high humidity inside the trailer may result in false test results.

- If running a Pretrip Test on a trailer loaded with sensitive cargo, monitor the load temperature during the test as normal temperature control is suspended during pre-trip operation.
- Always perform Pretrip Tests with the trailer cargo doors closed to prevent false test failures.

Pretrip Test Sequence

Pretrip tests proceed in the order shown below. A Full Pretrip Test is started with the engine or motor not running and includes all tests. A Running Pretrip Test is started with the engine or motor running and does not include the Amp Checks or Engine Start Check.

- **Amp Checks:** Each electrical control component is energized and the current drawn is confirmed as within specification.
- **Engine Start:** The engine will start automatically.
- **Defrost:** If the coil temperature is below 45 F (7 C), a defrost cycle is initiated.
- **RPM Check:** The engine RPM in high and low speed is checked during the Cool Check.
- **Zone 1 Cool Check:** The ability of the unit to cool in low speed is checked.
- **Zone 1 Heat Check:** The ability of the unit to heat in low speed is checked.
- **Zone 1 Return to Cool Check:** The ability of the unit to return to cool mode is checked.
- **Zone 2 Cool Check:** The ability of the unit to cool in low speed is checked.
- **Zone 2 Heat Check:** The ability of the unit to heat in low speed is checked.
- **Zone 2 Return to Cool Check:** The ability of the unit to return to cool mode is checked.
- **Zone 3 Cool Check:** The ability of the unit to cool in low speed is checked.
- **Zone 3 Heat Check:** The ability of the unit to heat in low speed is checked.
- **Zone 3 Return to Cool Check:** The ability of the unit to return to cool mode is checked.

Operating Instructions

- **Report Test Results:** The test results are reported as PASS, CHECK, or FAIL when the Pretrip Test is completed. If test results are CHECK or FAIL, alarm codes will exist to direct the technician to the source of the problem.

Performing a Pretrip Test

If a Pretrip Test is initiated with the engine shut down, a Full Pretrip Test will be performed. If a Pretrip Test is initiated with the engine or motor running, a Running Pretrip Test is performed.

- Before initiating a Pretrip Test, clear all alarm codes.
- To stop a Pretrip Test at any time, turn the unit off.

Pretrip Tests are initiated using the Pretrip Menu. From the Standard Display, press the MENU Key (Figure 61, p. 66).

Figure 61. MENU Key

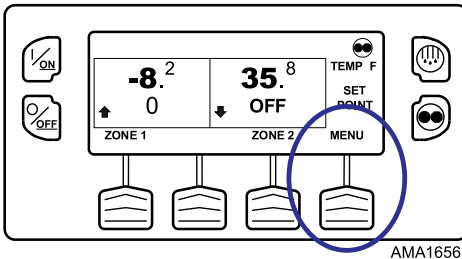

AMA1656

The Main Menu will appear. Press the UP or DOWN Key as required to choose the Pretrip Menu. When the Pretrip Menu is shown press the SELECT Key to start a Pretrip Test (Figure 62, p. 66).

Figure 62. Select Key

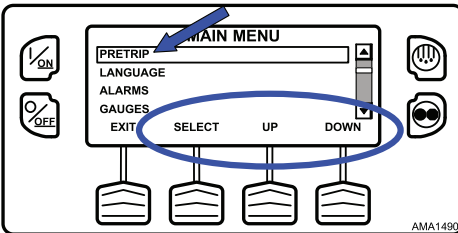

AMA1490

The display will briefly show PROGRAMMING PRETRIP MODE (Figure 63, p. 67). If the unit is not running, a Full Pretrip Test will be initiated. If the unit is running in either diesel or electric mode, a Running Pretrip Test will be performed.

Figure 63. Programming Trip Mode

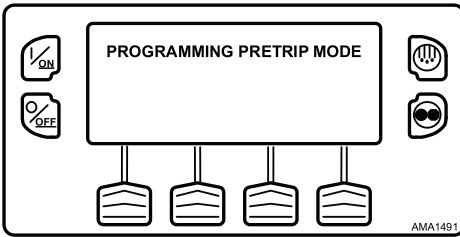

If all alarms were not cleared, a prompt appears (Figure 64, p. 67). Exit the Pretrip Test, clear all alarms, and repeat the Pretrip Test.

Figure 64. Alarms Not Cleared

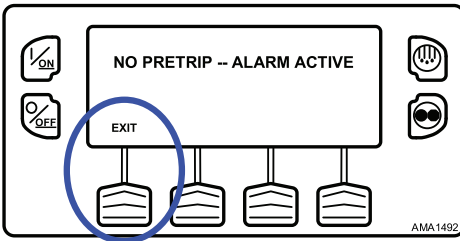

If all alarms were cleared, the Pretrip Test display appears (Figure 65, p. 67).

Figure 65. Pretrip Test

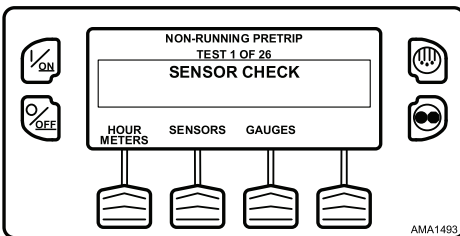

Operating Instructions

- The top line of the display indicates the unit is performing the non-running portion of the Pretrip Test.
- The second line measures test progress. The number of tests completed of the total number of tests to be performed is shown. In the example above, the unit is performing Test 1 of 26, Sensor Check.
- The soft keys may be used during the Pretrip Test to select the Hourmeter, Gauge, or Sensor menus.
- To stop a Pretrip Test at any time turn the unit off. This will generate Alarm Code 28 Pretrip Abort. Other alarm codes may also be generated. This is normal when the Pretrip Test is halted before completion.

When the non-running tests are complete, the unit will start automatically and continue with the Running Pretrip Test. In the example shown ([Figure 66, p. 68](#)) the unit is in the Running Pretrip and is performing Test 3 of 15, Cool Test.

Figure 66. Cool Test

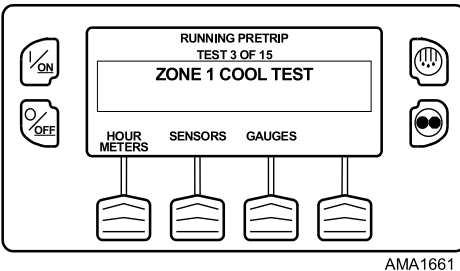

When all tests are complete, the results are reported as PASS, CHECK, or FAIL ([Figure 67, p. 68](#)). If the results are CHECK or FAIL, the accompanying alarm codes will direct the technician to the cause of the problem.

Figure 67. Pretrip Pass

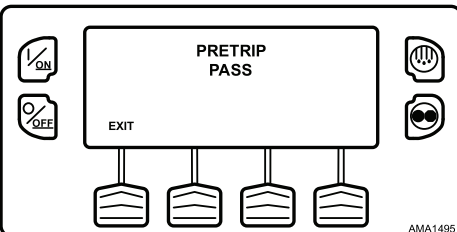

If the Pretrip Test results are CHECK or FAIL, the problem should be diagnosed and corrected by a Thermo King service technician before the unit is released for service.

To return to the Main Menu, press the EXIT Key. To return to the Standard display press the EXIT Key again.

See summary of "Performing a Pretrip Test" displays () and ().

Flash Drive

If a properly configured USB Flash Drive is currently connected to the USB Port on the unit Control Panel, the Flash Drive Menu will appear as a Main Menu selection. If a properly configured USB Flash Drive is connected to the USB Flash Drive connector, this feature allows the operator to select the desired Flash Drive function. If enabled when the Flash Drive was configured, the following functions may be available:

Download

- Download the ServiceWatch Data Logger
- Download the CargoWatch Data Logger

Flashload

- Flash load Base Controller Software
- Flash load HMI Control Panel Software

Flash Drive Icon

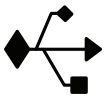

- The USB Icon ([Figure 68, p. 70](#)) will appear in the upper left corner of the display as shown below when a USB Flash Drive is inserted in the USB Flash Drive USB Port on the Unit Control Panel.
- The USB Icon will also appear if a computer is connected to the USB PC USB Port on the Unit Control Panel or inside the control box.

THERMO KING
Operating Instructions

Figure 68. Flash Drive Icon

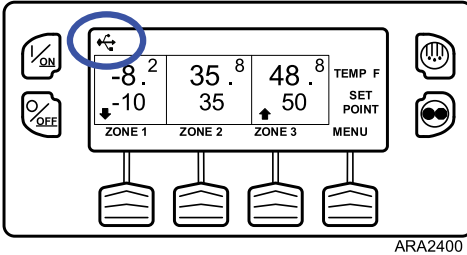

Selecting the Flash Drive Menu from the Main Menu (If Already Connected)

To select the Flash Drive Menu, press the MENU Key (Figure 69, p. 70). The Main Menu will appear.

Figure 69. Menu Key

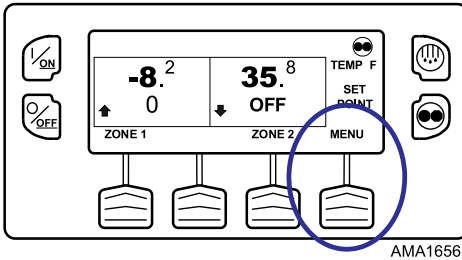

If a properly configured USB Flash Drive is connected to the Flash Drive Only USB Port on the Control Panel, the Flash Drive Menu will appear as a main Menu selection. Press the UP or DOWN Key as required to choose the Flash Drive Menu. When the Flash Drive Menu is shown, press the SELECT Key to select the Flash Drive Menu (Figure 70, p. 71).

Figure 70. Flash Drive Menu

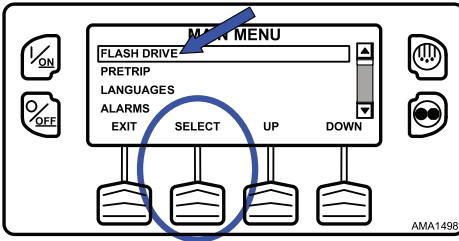

Flash Drive (If Connected While the Unit is Turned On)

If a properly configured USB Flash Drive is connected to the USB Port on the unit Control Panel while the unit is turned on, a Flash Drive indication will appear for several seconds and the Flash Drive Menu will be shown.

Removing the Flash Drive

If the Flash Drive is disconnected, the display shown (Figure 71, p. 71) will appear for 30 seconds and the display will return to the Standard Display. To return to the Standard Display, immediately press the EXIT Soft Key.

Figure 71. Flash Drive Removed

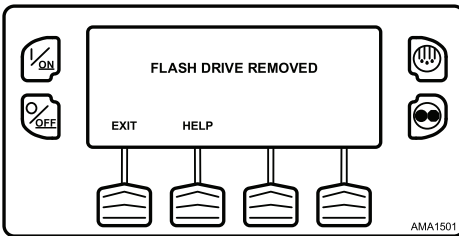

If the HELP Soft Key is pressed, the display shown (Figure 72, p. 72) will appear.

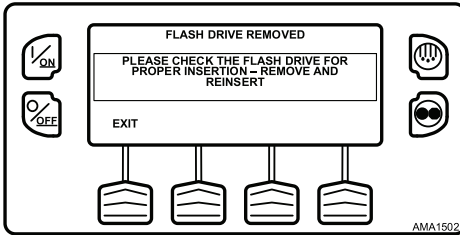
Figure 72. Help Soft Key Pressed

Languages

If Languages are not enabled from the Guarded Access Menu, this feature will not appear in the Main Menu.

Important: Exercise care when changing languages. Once changed, all HMI Control Panel displays will be in the new language.

Available Languages

The following languages are available:

English French Spanish Portuguese

Selecting an Alternate Language

To select an alternate language, press the MENU Key (Figure 73, p. 72).

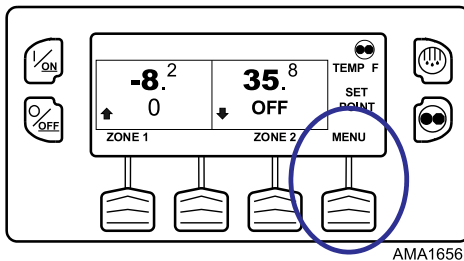
Figure 73. Menu Key

The Main Menu will appear. If more than one language is enabled, the Language Menu will appear as a Main Menu selection (Figure 74, p. 73). Press the UP or DOWN Key as required to choose the Language Menu. When

the Language Menu is shown press the SELECT Key to select the Language Menu.

Figure 74. Main Menu

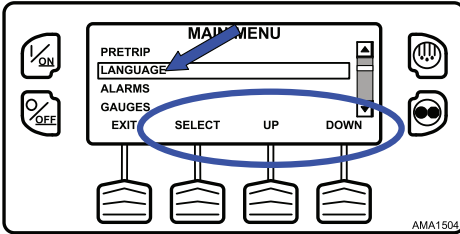

The Language Menu will appear as shown (Figure 75, p. 73). Press the + or - Keys to select the desired language. Only languages enabled from the Guarded Access Menu are available. When the desired language is shown, press the YES Key to confirm the choice.

Figure 75. Language Menu

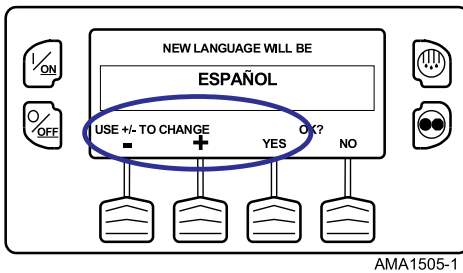

The display will briefly show PROGRAMMING LANGUAGE - PLEASE WAIT in the new language. The display will then return to the Language Menu, but will show the new language. Spanish is shown in the example (Figure 76, p. 74).

Operating Instructions

Figure 76. New Language (Example: Spanish)

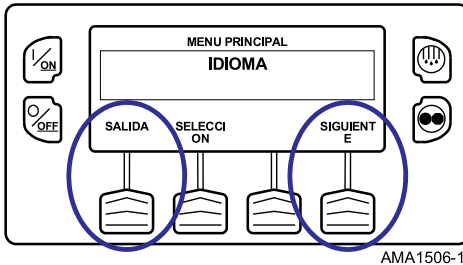

Repeat the process to select a different language. To select a different Main Menu item, press the NEXT (SIGUIENTE) Key. To return to the Standard Display, press the EXIT (SALIDA) Key. All displays will now be in the new language. Español (Spanish) is shown in the example (Figure 77, p. 74).

See summary of "Languages (If Enabled)" displays ().

Figure 77. Spanish (Example)

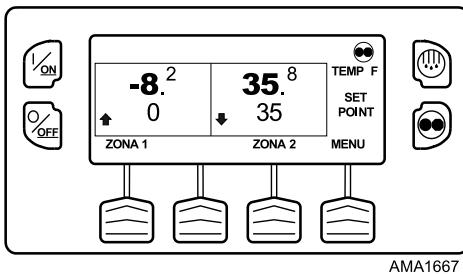

Language Menu Quick Access

Should it be necessary at any time to change to English or any other installed language, return to the Standard Display and then press and hold the first and last soft keys for five seconds as shown below. The Standard Display shown (Figure 78, p. 75) is Español (Spanish).

After five seconds, the Language Menu will appear in the current language as shown (Figure 79, p. 75). Press the + or - Keys to select the desired language. When the desired language is shown, press the SI (YES) Key to confirm the choice.

Figure 78. First, Last Keys

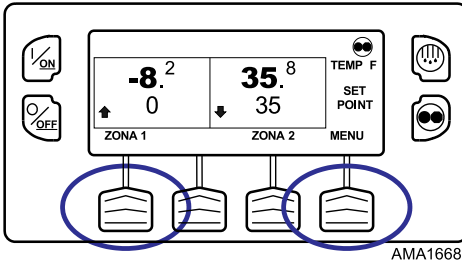
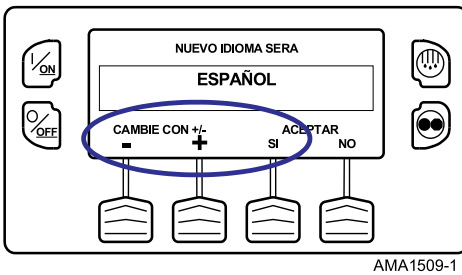

Figure 79. Select Desired Language



Note: All languages in the installed software can be selected using this method.

Alarms

The Alarms Menu allows the operator to view all alarms and clear most alarms.

Log Alarm

Log Alarms are indicated for 30 seconds each time the unit is turned on. This level of alarm serves as a notice to take corrective action before a problem becomes severe. Maintenance items such as maintenance hourmeter time-outs are log alarms. The TemperatureWatch screen is not disabled if only log alarm(s) are active.

When the unit is turned on, the display will show the Thermo King Logo and then the "Configuring System" message. If Log Alarm(s) are present, the Log Alarm notice will appear on the display for 30 seconds as shown (Figure 80, p. 76). The remote indicator alarm light (if installed) will also be on

Operating Instructions

during this period. After 30 seconds, the Standard Display will appear and the remote indicator alarm light will go off.

Note: The Alarm Icon does not appear on startup with log alarms present.

Figure 80. Log Alarm Notice

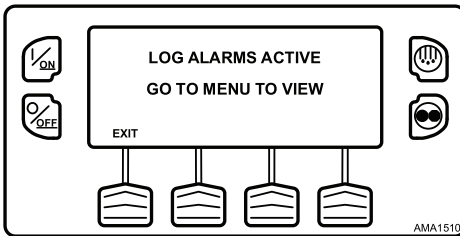

Note: If required, an engine start may occur while the display above is shown. This is normal operation.

Check Alarm

Check Alarms are indicated by a steady alarm icon at the side of the display. If the alarm is specific to a zone, a smaller alarm icon will appear next to the affected zone. This level of alarm serves as a notice to take corrective action before a problem becomes severe. The unit will run with Check Alarms but some features and functions may be inhibited. The TemperatureWatch screen is disabled if a Check Alarm is active.

Unit Level Check Alarm

If the alarm pertains to the entire system (not an individual zone, e.g, Alarm Code 10), the alarm icon will appear at the right side of the display as shown (Figure 81, p. 76). Both Zone Specific and Unit Specific Alarms can exist at the same time.

Figure 81. Alarm Icon

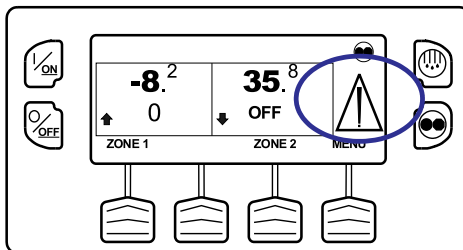

Zone Level Check Alarm

If the alarm is zone specific, the Alarm Icon will appear in the offending zone as shown (Figure 82, p. 77). In the example, an alarm exists in Zone 2.

Figure 82. Alarm for Zone 2

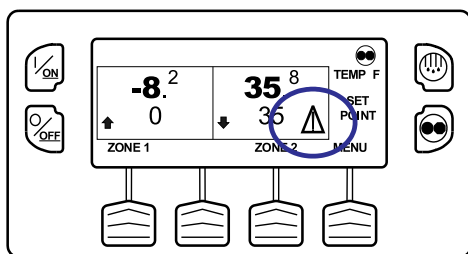

AMA1672

Unit Level Prevent Alarm

Unit Level Prevent Alarms are also indicated by a steady alarm icon at the side of the display. The unit will be temporarily shut down if a Prevent Alarm is active. The unit will remain shut down for a timed restart interval or until the fault conditions are corrected and then restart. If the unit is in a temporary shutdown, Alarm Code 84 Restart Null will be present along with the associated Prevent Alarm. In most cases, the unit will restart with reduced performance to determine if continued operation is possible. If the alarm does not reoccur, the unit will then return to full performance. If the unit is operating with reduced performance, Alarm Code 85 Forced Unit Operation may also be present under some conditions. In general, if the alarm condition reoccurs a defined number of times, the alarm is set as a Shutdown Alarm and no further restarts are possible. The TemperatureWatch screen is disabled if a Unit Level Prevent Alarm is active.

Note: *If the Restart After Shutdown feature in the Guarded Access Menu is set for CONTINUOUS, an unlimited number of restart attempts are allowed.*

Zone Level Prevent Alarm

A Zone Level Prevent Alarm will force the affected zone into a temporary shutdown, but allow the unit to continue to run as required by the host unit or other zones. A small alarm icon will appear next to the affected zone. If zone Prevent Alarms occur in all zones, the unit will be forced into a unit level Prevent Shutdown. The TemperatureWatch screen is disabled if a Zone Level Prevent Alarm is active.

Operating Instructions

Shutdown Alarm

If a Shutdown Alarm occurs while the unit is running, it will be indicated by all of the following (Figure 83, p. 78):

- The Alarm Icon will appear.
- The display, backlight, and optional remote alarm light will flash on and off.
- The display will alternate from normal to inverted and back (light areas become dark and dark areas become light).

Shutdown Alarms will force the unit into shutdown. The unit will remain in shutdown until the Shutdown Alarm is manually cleared. Exceptions are some engine and electric Shutdown Alarms that become Log Alarms when switched to the alternate operating mode (diesel to electric or electric to diesel). The TemperatureWatch screen is disabled if a unit level Shutdown Alarm is active.

Figure 83. Shutdown Alarm Screen

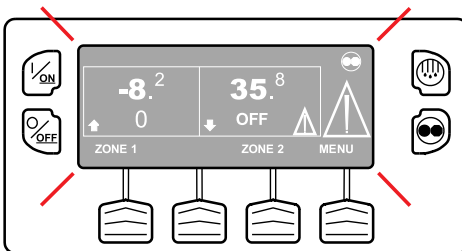

AMA1673

Unit Level Shutdown Alarm

Unit Level Shutdown Alarms will force the unit into shutdown. The unit will remain in shutdown until the Shutdown Alarm is manually cleared. Exceptions are some engine and electric Shutdown Alarms that become Log Alarms when switched to the alternate operating mode (diesel to electric or electric to diesel). The TemperatureWatch screen is disabled if a Unit Level Shutdown Alarm is active.

Zone Level Shutdown Alarm

A zone Shutdown Alarm will force the affected zone to shutdown, but allow the unit to continue to run as required by the host unit or other zones. A small alarm icon will appear next to the affected zone and blink with a period of half second on - half second off. If zone Shutdown Alarms occur in all

zones, the unit will shut down and Alarm Code 114 Multiple Alarms - Can Not Run will be set.

Pretrip Alarm

If an alarm occurs during a Pretrip Test, the alarm code will be displayed as Pretrip Alarm XX, where XX is the alarm code.

Zone Off Alarm

If the host unit is turned on, zone conditions are monitored even if the zone is turned off. For example, temperature sensor Alarm Codes 02, 03, and 04 can be set for a zone even when that zone is turned off.

Low Battery Voltage

If Alarm Code 61 Low Battery Voltage is set as a Shutdown Alarm, no subsequent alarm codes will be set with the exception of Alarm Code 28 Pretrip Abort.

Alarm Codes When Switching Between Diesel and Electric

If a shutdown alarm occurs that affects only diesel mode operation and the unit is switched to electric, the diesel mode shutdown alarm becomes an electric mode log alarm. This allows the unit to run in electric mode without clearing the shutdown alarm that is preventing diesel mode operation. If the unit is switched back to diesel mode, the alarm again become a diesel mode shutdown alarm and prevents unit operation.

In the same manner, if a shutdown alarm occurs that affects only electric mode operation and the unit is switched to diesel, the electric mode shutdown alarm becomes a diesel mode log alarm to allow diesel mode operation. If the unit is switched back to electric mode, the alarm reverts to an electric mode shutdown alarm and prevents unit operation. If the unit is configured for electric to diesel Auto-Switch, it automatically starts and runs in diesel mode if an electric shutdown occurs.

Clearing Alarm Codes

Most alarm codes can be cleared conventionally from the Alarm Menu using the CLEAR Key.

The following control and display sensor alarm codes can only be cleared from the Guarded Access Menu:

- Alarm Code 03 Check Control Return Air Sensor
- Alarm Code 04 Check Control Discharge Air Sensor
- Alarm Code 74 Controller Reset to Defaults.

Operating Instructions

The following alarm codes clear automatically:

- Alarm Code 64 Pretrip Reminder - Clears when a Pretrip Test is performed.
- Alarm Code 84 Restart Null - Clears when the unit is no longer in a restart null due to a Prevent Alarm.
- Alarm Code 85 Forced Unit Operation - Clears when the unit is no longer running in a forced mode due to a Prevent Alarm.
- Alarm Code 91 Check Electric Ready Input - Clears automatically when electric power is restored.
- Alarm Code 92 Sensor Grades Not Set - Clears when the sensor grade is changed from 5H.

If the Limited Alarm Restarts feature is enabled, the following additional alarm codes may only be cleared from the Guarded Access Menu. If this is the case, the CLEAR soft key will not appear if the alarms are displayed from the Main Menu or the Maintenance Menu.

- Alarm Code 10 High Discharge Pressure
- Alarm Code 23 Cooling Cycle Fault
- Alarm Code 24 Heating Cycle Fault
- Alarm Code 32 Refrigeration Capacity Low

Displaying and Clearing Alarm Codes

Alarms are displayed and cleared using the Alarm Menu. From the Standard Display, press the MENU Key (Figure 84, p. 80).

Figure 84. Menu Key

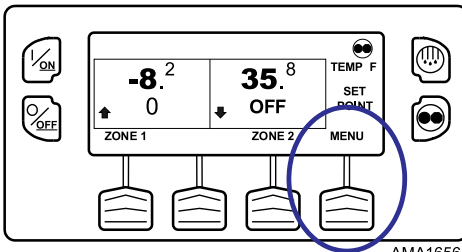

AMA1656

The Main Menu will appear. Press the UP or DOWN Key as required to choose the Alarms Menu (Figure 85, p. 81). When the Alarms Menu is shown, press the SELECT Key to select the Alarms Menu.

Figure 85. Up/Down, Select Keys

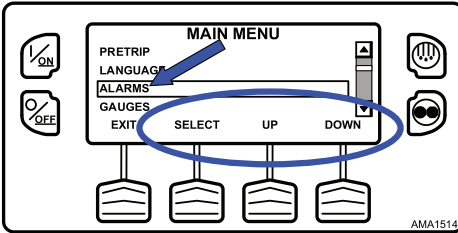

The number of alarms (if more than one) and a list of the alarms with the most recent alarm first will be shown. In the example shown (Figure 86, p. 81), there are two alarms. The most recent is Alarm Code 5 Check Ambient Temp Sensor.

Figure 86. Alarms Menu

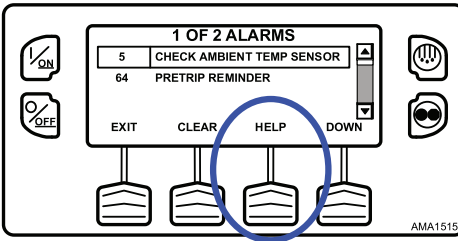

If necessary to view all alarms, scroll down using the DOWN Key (Figure 87, p. 81).

Figure 87. Down Key

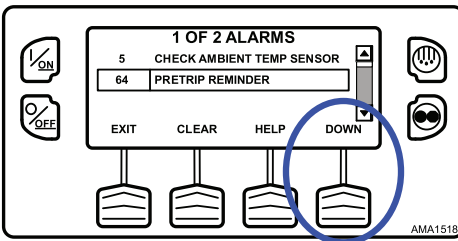

If the alarm situation has been resolved, press the CLEAR Key to clear the alarm (Figure 88, p. 82).

Figure 88. Clear Key

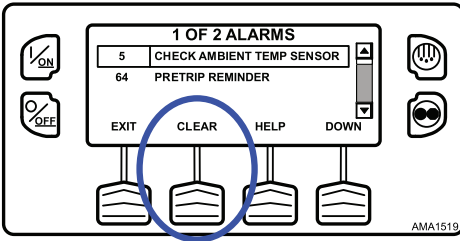

The display will briefly show CLEARING ALARM 5 – PLEASE WAIT and the Alarm Menu will reappear (Figure 89, p. 82).

Alarm Code 64 Pretrip Reminder cannot be cleared using the CLEAR Key. This alarm will clear automatically when a Pretrip Test is run.

Figure 89. Pretrip Reminder

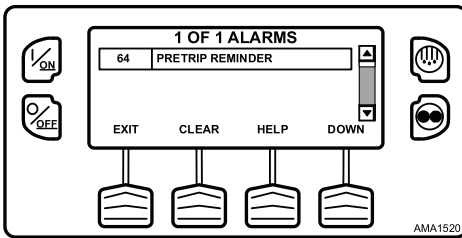

If a serious condition occurs, the unit will be shut down to prevent damage to the unit or the load. If this occurs, the Alarm Icon will appear, the display and backlight will flash on and off (Figure 90, p. 82).

Figure 90. Alarm Screen

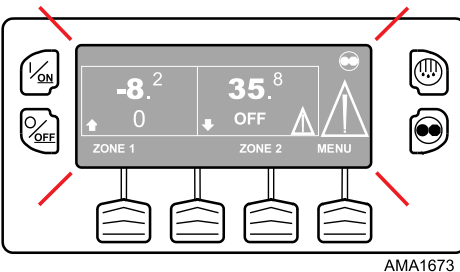

The Alarm Menu display will display the Shutdown Alarm Code. For additional information regarding the alarm shown on the display, press the HELP Key (Figure 91, p. 83).

Figure 91. Help Key

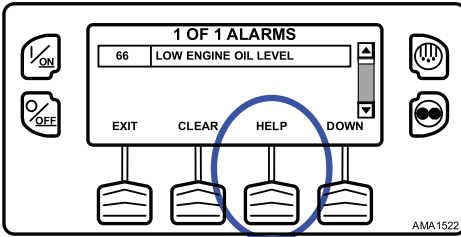

A help message will appear. Press the EXIT Key to return to the Alarms Menu (Figure 92, p. 83). Check the oil level and add oil as required, clear the alarm and restart the engine.

Figure 92. Exit Key

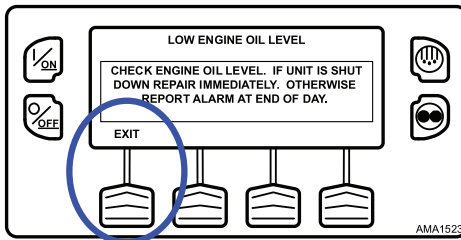

To return to the Main Menu press the EXIT Key. To return to the Standard display press the EXIT Key again.

Important Alarm Notes

- If an alarm will not clear, the condition may still exist. If the alarm is not corrected, it will not clear or may be immediately set again.
- If an alarm cannot be cleared from the Main menu, the Clear Key will not appear. These alarms must be cleared from the Maintenance or Guarded Access Menus.

See summary of "Displaying and Clearing Alarm Codes" displays () ().

Gauges

The Gauges Menu allows the operator to view the unit gauges and I/O conditions. The unit gauges can always be viewed from the Main Menu and also from the Maintenance Menu.

Displaying Gauges

Gauges are displayed using the Gauges Menu. From the Standard Display, press the MENU Key (Figure 93, p. 84).

Figure 93. Menu Key

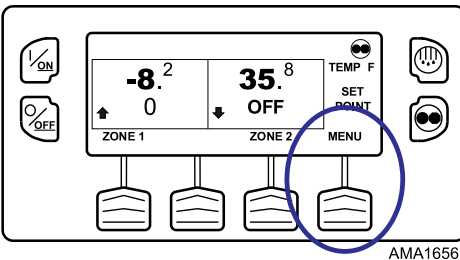

The Main Menu will appear. Press the UP or DOWN Key as required to choose the Gauges Menu. When the Gauges Menu is selected, press the SELECT Key to choose the Gauges Menu (Figure 94, p. 84).

Figure 94. Up, Down, Select Keys

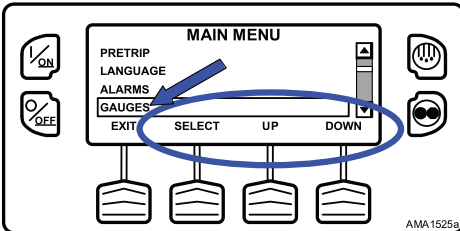

The first gauge display will appear. Press the NEXT and BACK Keys to scroll through the gauges and I/O conditions. Pressing the LOCK Key will lock the current gauge on the display (Figure 95, p. 85).

Figure 95. Next, Back, Lock Keys

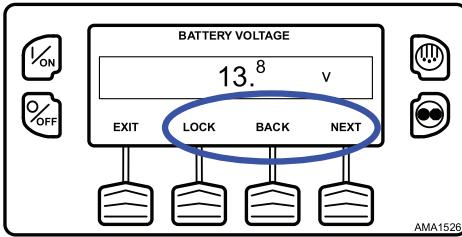

The gauges and I/O conditions available are shown below. Not all gauges or I/O conditions may appear depending on unit configuration and software revision.

To return to the Main Menu, press the EXIT Key. To return to the Standard Display, press the EXIT Key again.

Gauges Available

Coolant Temperature: Displays the temperature of the engine coolant.

Coolant Level: Displays the coolant level in the overflow tank.

Engine Oil Pressure: Displays the engine oil pressure as OK or LOW.

Engine Oil Level Switch: Displays the engine oil level as OK or LOW.

Amps: Displays the current flow in amps flowing to or from the unit battery.

Battery Voltage: Displays the voltage of the unit battery.

Engine RPM: Displays the engine speed in RPMs.

Fuel Level Sensor: Displays the fuel level if a fuel level sensor is installed.

Discharge Pressure: Displays the unit discharge pressure.

Suction Pressure: Displays the unit suction pressure.

ETV Position: Displays the current position of the ETV valve.

Motor RPM: Displays motor RPM.

I/O (Input/Output State): Displays the current state of the input/output devices listed below:

High Speed Relay	Purge Valve	Drain Hose Heater Zone 2
Run Relay	Liquid Line Solenoid Zone 1	Liquid Line Solenoid Zone 3
Run Relay Feedback	Fresh Air Exchange Output (if configured)	Hot Gas Solenoid Zone 3

Operating Instructions

Alternator Excite Output	Fresh Air Exchange Feedback (if configured)	Suction Line Solenoid Zone 3
Condenser Inlet Solenoid	Diesel/Electric Relay (SmartPower™ units only)	Drain Hose Heater Zone 3
Receiver Tank Inlet Pressure Solenoid	Hot Gas Solenoid Zone 1	Fan Output Zone 2
Motor RPM	Suction Line Solenoid Zone 1	Fan Output Zone 3
Spare Digital Input 1, 2, 3, 4	Liquid Line Solenoid Zone 2	Electric Ready Input (SmartPower™ units only)
Spare Analog Input 1, 2	Hot Gas Solenoid Zone 2	Electric overload (SmartPower™ units only)
Spare Output 1, 2, 3, 4, 5	Suction Line Solenoid Zone 2	

Sensors

The Sensors Menu allows the operator to view the unit and CargoWatch Data Logger temperature sensors. The sensors can always be viewed from the Main Menu and also from the Maintenance Menu.

Displaying Sensors

Sensors are displayed using the Sensors Menu. From the Standard Display, press the MENU Key (Figure 96, p. 86).

Figure 96. Menu Key

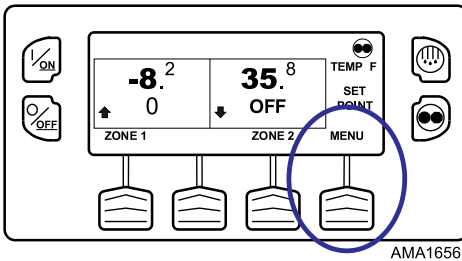

The Main Menu will appear. Press the UP or DOWN Key as required to choose the Sensors Menu. When the Sensors Menu is selected, press the SELECT Key to choose the Sensors Menu (Figure 97, p. 87).

Figure 97. Up, Down, Select Keys

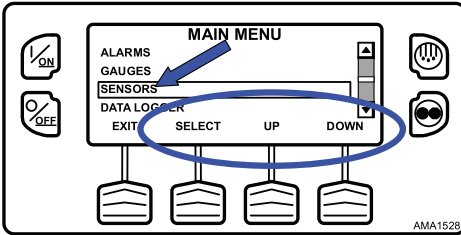

The first sensors display will appear. Press the NEXT and BACK Keys to scroll through the sensors and I/O conditions. Pressing the LOCK Key will lock the current sensor on the display (Figure 98, p. 87).

Figure 98. Next, Back, Lock Keys

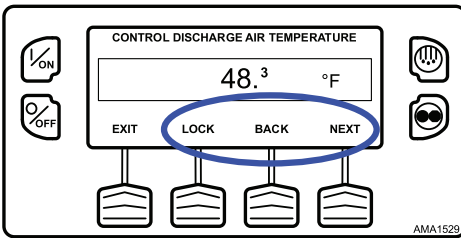

The sensors available are shown below.

To return to the Main Menu, press the EXIT Key. To return to the Standard Display, press the EXIT Key again.

Sensors Available

Zone 1 Return Air Temperature: Displays the temperature of the Zone 1 Return Air Sensor.

Zone 1 Discharge Air Temperature: Displays the temperature of the Zone 1 Discharge Air Sensor.

Zone 1 Temperature Differential: Displays the Zone 1 Temperature Differential.

Zone 1 Evaporator Coil Temperature: Displays the temperature of the Zone 1 Evaporator Coil sensor.

Zone 2 Return Air Temperature: Displays the temperature of the Zone 2 Return Air Sensor.

Operating Instructions

Zone 2 Discharge Air Temperature: Displays the temperature of the Zone 2 Discharge Air Sensor.

Zone 2 Temperature Differential: Displays the Zone 2 Temperature Differential.

Zone 2 Evaporator Coil Temperature: Displays the temperature of the Zone 2 Evaporator Coil sensor.

Zone 3 Return Air Temperature: Displays the temperature of the Zone 3 Return Air Sensor.

Zone 3 Discharge Air Temperature: Displays the temperature of the Zone 3 Discharge Air Sensor.

Zone 3 Temperature Differential: Displays the Zone 3 Temperature Differential.

Zone 3 Evaporator Coil Temperature: Displays the temperature of the Zone 3 Evaporator Coil sensor.

Ambient Air Temperature: Displays the temperature of the ambient air temperature sensor.

Spare 1 Temperature: Displays the temperature of the Spare 1 temperature sensor.

Spare 2 Temperature: Displays the temperature of the Spare 2 temperature sensor.

Spare 3 Temperature: Displays the temperature of the Spare 3 temperature sensor.

Data Logger Sensor 1 Temperature: Displays the temperature of the CargoWatch Data Logger 1 temp sensor.

Data Logger Sensor 2 Temperature: Displays the temperature of the CargoWatch Data Logger 2 temp sensor.

Data Logger Sensor 3 Temperature: Displays the temperature of the CargoWatch Data Logger 3 temp sensor.

Data Logger Sensor 4 Temperature: Displays the temperature of the CargoWatch Data Logger 4 temp sensor.

Data Logger Sensor 5 Temperature: Displays the temperature of the CargoWatch Data Logger 5 temp sensor.

Data Logger Sensor 6 Temperature: Displays the temperature of the CargoWatch Data Logger 6 temp sensor.

Board Temperature Sensor: Displays the temperature of the HMI control panel PC board.

Data Logger (CargoWatch™)

The CargoWatch Data Logger is physically located in the HMI Control Panel. It can support up to six optional temperature sensors.

When shipped from the factory, CargoWatch sensors 1 and 2 are turned on to be logged and CargoWatch sensors 3 through 6 are turned off. Also, digital input 1 is turned on to be logged and digital inputs 2 through 4 are turned off. Sensors and digital inputs can be turned on, off, and configured using the CargoWatch menu in Guarded Access or with WinTrac.

A Start of Trip can be sent to the unit ServiceWatch and CargoWatch Data Loggers. In addition, the CargoWatch Data Logger contents can be printed with a hand-held printer.

The ServiceWatch and CargoWatch Data Logger are accessed using the Data Logger Menu. From the Standard Display, press the MENU Key (Figure 99, p. 89).

Figure 99. Menu Key

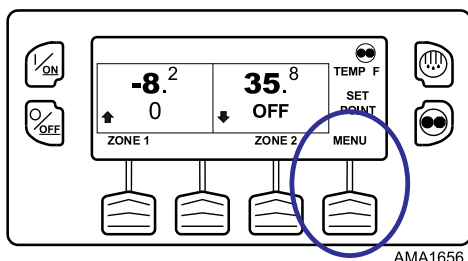

The Main Menu will appear. Press the UP or DOWN Key as required to choose the Data Logger Menu. When the Data Logger Menu is selected, press the SELECT Key to choose the Data Logger Menu (Figure 100, p. 89).

Figure 100. Up, Down, Select Keys

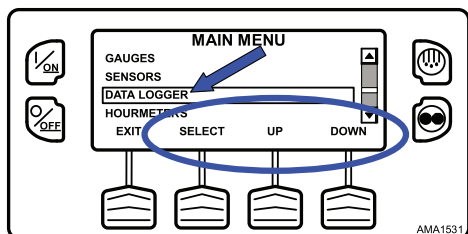

Operating Instructions

The Data Logger Menu will appear.

Sending Start of Trip Marker to CargoWatch and ServiceWatch Data Loggers

To send a Start of Trip marker to the CargoWatch and ServiceWatch Data Loggers, press the SELECT Key. The display will briefly show START OF TRIP COMPLETE to confirm that a Start of Trip marker was set in the CargoWatch Data Logger (Figure 101, p. 90).

Figure 101. Select Key, Start of Trip Complete

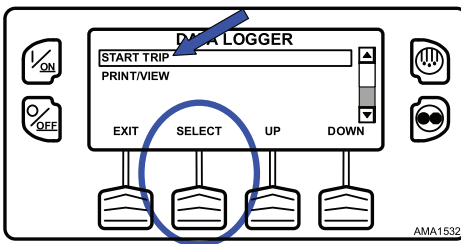

Note: The start of trip marker is sent to both the CargoWatch and ServiceWatch data loggers.

Printing CargoWatch Data Logger Reports

Press the DOWN Key to select the PRINT / VIEW feature and press the SELECT Key to choose Print/View (Figure 102, p. 90).

Figure 102. Select Key, Print/View

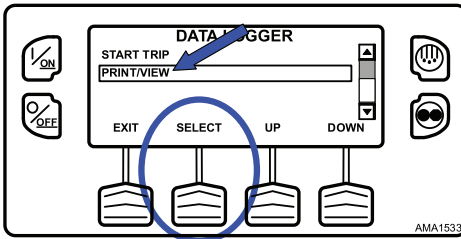

The Print Data Menu will appear. The first Print Data Menu allows the operator to print a Delivery Ticket using a hand held printer. Pressing the SELECT Key will print the ticket (Figure 103, p. 91). The Delivery Ticket is a short ticket that shows delivery specific details including the current temperature. A Sample Delivery Ticket is shown (Figure 104, p. 91).

Figure 103. Select Key, Print Delivery Ticket

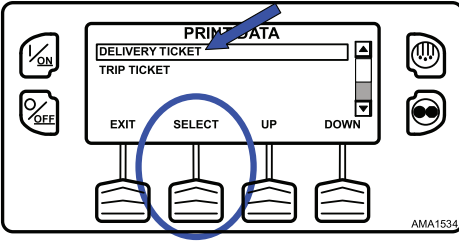

Figure 104. Sample Delivery Ticket

```

UNIT SERIAL NUMBER:          xxxxxxxxxx
CONTROLLER SERIAL NUMBER:    A00021506190T3
TRAILER ID:                  xxxxxxxxxx
CONTROLLER VERSION NUMBER:   B007
CONTROLLER TYPE:             SR2
DATALOGGER VERSION NUMBER:   6512
TEMPERATURE UNITS:          FAHRENHEIT
START:                       05/30/08 08:29:08
FINISH:                       05/30/08 09:18:33
SENSORS:                      2
SETPOINT:                    32.0

Sensor   Min   Ave   Max   Last
#1:     35   35   35   35
#2:     ---  ---  ---  ---

SENSOR #1:                    LOG SENSOR 1
SENSOR #2:                    LOG SENSOR 2
    
```

AMA1535

Pressing the DOWN Key allows the operator to print a Trip Ticket using a hand held printer. Press the SELECT Key to print the ticket (Figure 105, p. 91). The Trip Ticket is a long ticket that shows details for the current trip including a temperature history. The Trip Ticket is also called a Journey Ticket. A sample Trip Ticket is shown (Figure 106, p. 92).

Figure 105. Select Key, Print Trip Ticket

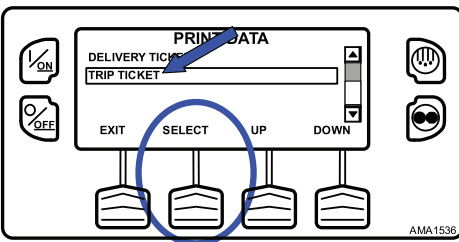

Operating Instructions

Figure 106. Sample Trip Ticket

UNIT SERIAL NUMBER:	XXXXXXXXXX
CONTROLLER SERIAL NUMBER:	A00021506190T3
TRAILER ID:	XXXXXXXXXX
CONTROLLER VERSION NUMBER:	B007
CONTROLLER TYPE:	SR2
DATALOGGER VERSION NUMBER:	6512
TEMPERATURE UNITS:	FAHRENHEIT
START:	05/30/08 09:50:08
FINISH:	05/30/08 13:07:33
SENSORS:	1
SETPOINT:	32.0
30 - MAY - 2008	
1305	35.0
1250	35.2
1235	35.1
1220	35.2
1205	35.1
30 - MAY - 2008	
1150	35.0
1135	35.0
1120	35.0
1105	34.9
1050	35.0
1035	35.0
1020	35.0
1005	35.1
0950	35.1
SENSOR #1:	LOG SENSOR 1
SENSOR #2:	LOG SENSOR 2
AMA1537	

To return to the Main Menu press the EXIT Key. To return to the Standard display press the EXIT Key again.

Hourmeters

The Hourmeters Menu allows the operator to view the unit hourmeters that have the view feature enabled in the Guarded Access Menu. If the view feature for a particular hourmeter is not enabled, that hourmeter will continue to accumulate time but cannot be viewed from the Main Menu. However, all hourmeters can be viewed from the Maintenance Menu, even if they are not enabled. The hourmeters shown below are implemented.

Viewing Hourmeters

Only Hourmeters that have been enabled in Guarded Access are shown from the Main Menu. The Hourmeters can be viewed only.

Hourmeters are displayed using the Hourmeter Display. From the Standard Display, press the MENU Key (Figure 107, p. 93).

Figure 107. Menu Key

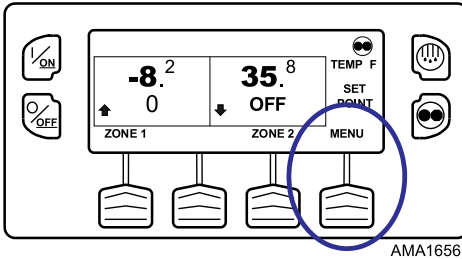

The Main Menu will appear. Press the UP or DOWN Key as required to choose the Hourmeter Menu. When the Hourmeter Menu is selected, press the SELECT Key to choose the Hourmeter Menu (Figure 108, p. 93).

Figure 108. Select Key

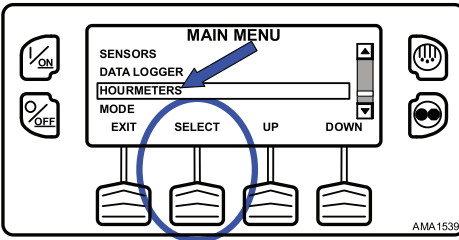

Press the UP or DOWN Key to scroll through the hourmeters (Figure 109, p. 93).

Figure 109. Up/Down Keys

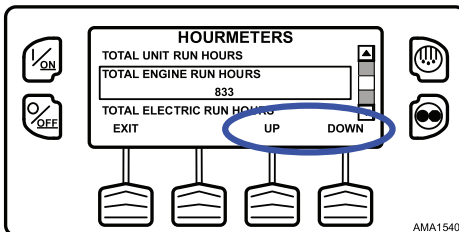

Hourmeter names and definitions are shown below in the order they appear. Only hourmeters enabled in the Guarded Access Menu will be shown. To return to the Standard Display, press the EXIT Key.

Operating Instructions

When shipped from the factory, only these hourmeters are enabled for viewing from the Main Menu:

- Total Unit Run Hours
- Total Engine Run Hours
- Total Electric Run Hours

To return to the Main Menu, press the EXIT Key. To return to the Standard Display, press the EXIT Key again.

Hourmeter Names and Definitions

Only configured hourmeters that have been enabled in the Viewable Hourmeter Setup Menu will be shown:

Hourmeter Name	Definition
Total Hours	Total number of hours the unit has been turned on (protection hours).
Total Run Time Hours	Total number of hours the unit has run in both diesel and electric mode.
Total Engine Run Hours	Total number of hours the unit has run in diesel mode.
Total Electric Run Hours	Total number of hours the unit has run in electric mode.
Zone 1 Run Time Hours	Total number of hours Zone 1 has run in any mode.
Zone 2 Run Time Hours	Total number of hours Zone 2 has run in any mode.
Zone 3 Run Time Hours	Total number of hours Zone 3 has run in any mode.
Total Run Reminder 1	User Programmable - The number of hours before a Total Unit Run Time Maintenance Reminder 1 occurs.
Total Run Reminder 2	User Programmable - The number of hours before a Total Unit Run Time Maintenance Reminder 2 occurs.
Pretrip Reminder	User Programmable - number of hours before a Pretrip Reminder occurs.
Engine Reminder 1	User Programmable - The number of hours before an Engine Run Time Maintenance Reminder 1 occurs.

Hourmeter Name	Definition
Engine Reminder 2	User Programmable - The number of hours before an Engine Run Time Maintenance Reminder 2 occurs.
Electric Reminder 1	User Programmable - The number of hours before an Electric Run Time Maintenance Reminder 1 occurs.
Electric Reminder 2	User Programmable - The number of hours before an Electric Run Time Maintenance Reminder 2 occurs.
Engine Timing Belt Accumulated Hours	Total number of hours the engine timing belt has accrued in diesel mode.

Important: *If a programmable hourmeter is not enabled or the view for that hourmeter is not turned on it will not appear in the display sequence.*

Mode

The Mode Menu allows the operator to change the unit operating modes that have been enabled in Guarded Access. Only Operating Modes that have been enabled from the Guarded Access > Main Menu Configuration Menu will be shown.

- Turns Off Cycle Sentry Mode/Turns On Cycle Sentry Mode (If Cycle Sentry is turned Off, unit runs in Continuous).
Note: *Selecting Cycle Sentry Mode or Continuous Mode can also be accomplished using the Cycle Sentry Key to the right of the display.*
- Allows Single Zone Control to be selected (if enabled from the Guarded Access > Main Menu Configuration Menu).
- Allows temperatures to be displayed in either Fahrenheit or Celsius degrees (if enabled from the Guarded Access > Main Menu Configuration Menu).
- Allows Keypad Lockout to be selected (if enabled from the Guarded Access > Main Menu Configuration Menu).
- Allows Sleep Mode to be set up and started (if enabled from the Guarded Access > Main Menu Configuration Menu).

When shipped from the factory, only the Cycle Sentry/Continuous Mode is enabled.

To return to the Main Menu, press the EXIT Key. To return to the Standard Display, press the EXIT Key again.

Operating Instructions

Using the Change Mode Menu

Mode changes are made using the Mode Menu. From the Standard Display, press the MENU Key (Figure 110, p. 96).

Figure 110. Menu Key

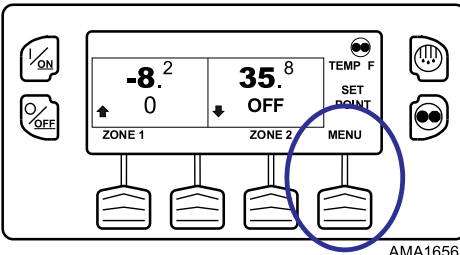

The Main Menu will appear. Press the UP or DOWN Key as required to choose the Mode Menu. When the Mode Menu is selected, press the SELECT Key to choose the Mode Menu (Figure 111, p. 96).

Figure 111. Up, Down, Select Keys

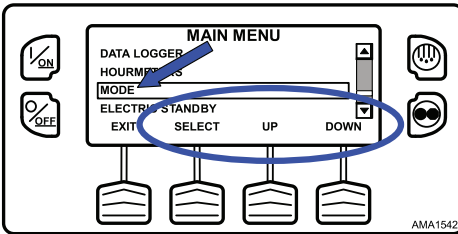

The first enabled Change Mode Menu selection will appear. To choose that function, press the SELECT Soft Key. To Scroll through the enabled features in the Change Mode Menu, press the UP and DOWN Soft Keys (Figure 112, p. 97).

Figure 112. Select, Up, Down Keys

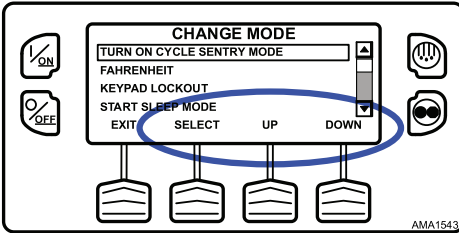

Possible mode selections are shown later in this section.

- Only those modes that have been enabled in Guarded Access > Main Menu Configuration will appear.
- To return to the Standard Display, press the EXIT Key.

Turn Cycle Sentry On or Off

Cycle Sentry can be turned on and off either by using the Cycle Sentry hard key at the right right side of the display or from the Main Menu.

Important: *If the unit is in Cycle Sentry Null and the mode is switched to Continuous Mode, the unit will start automatically.*

If the unit is operating in Cycle Sentry Mode, the Cycle Sentry Icon will be present in the upper right corner of the display as shown (Figure 113, p. 97). If the Cycle Sentry Icon is not present the unit is operating in Continuous Mode.

Figure 113. Cycle Sentry Icon

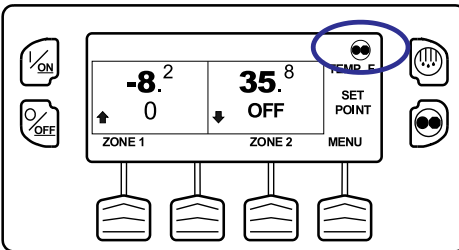

AMA1701

Using the Cycle Sentry Key

Cycle Sentry Mode or Continuous Mode is selected by pressing the Cycle Sentry Key as shown (Figure 114, p. 98).

THERMO KING

Operating Instructions

Figure 114. Cycle Sentry Key

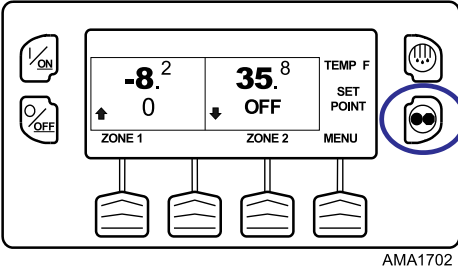

Using the Main Menu

From the Main Menu > Change Mode menu choose Turn On/Off Cycle Sentry Mode and press the SELECT Soft Key.

Figure 115. Select Key

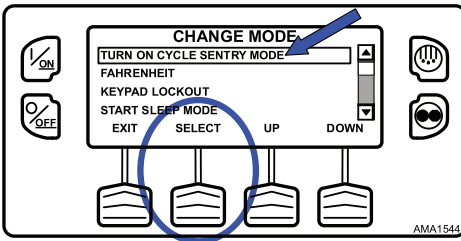

If the unit is running in Cycle Sentry Mode, press the SELECT Soft Key (Figure 116, p. 98) to turn off Cycle Sentry Mode as shown.

Figure 116. Select Key

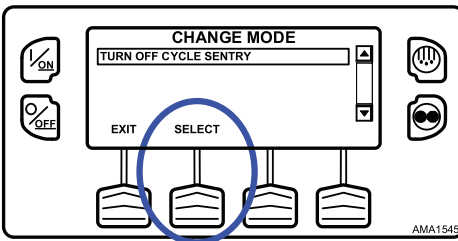

Confirmation screens will appear briefly, the unit will switch to Continuous Mode operation, and the Cycle Sentry Icon will disappear.

To turn Cycle Sentry back on, press the SELECT Key again.

To leave this menu without changing the setting, press the EXIT Soft Key. To return to the Standard Display, press the EXIT Soft Key again.

Important: *If the unit is in Cycle Sentry Null and the mode is switched to Continuous Mode, the unit will start automatically.*

Single Zone Control - Multi Zone Control

The following differences exist when operating the unit in Single Zone Control Mode.

- Single Zone Control Mode will appear in the Mode Menu only if the Single Zone Control feature has been enabled in the Guarded Access > Main Menu Configuration Menu. If the feature is enabled, Single Zone Control will appear in the Main Menu > Mode Menu.
- If Single Zone Control operation is selected, all zones will be forced on and will control to the same setpoint. All dividing wall(s) should be repositioned to create one large compartment. With the exception of defrost, the operating mode of each zone evaporator(s) will be same when in this mode.
- Unit control is based on the temperature sensors of one zone. Zone 1 is controlling or host, Zones 2 and 3 are backup.
- If Single Zone Control operation is selected the Single Zone Standard Display provides one soft key labeled Set Point as shown (Figure 117, p. 99). This allows the setpoint for all zones to be changed simultaneously.
- If Single Zone Control operation is selected the individual zones cannot be turned off. The unit and all zones are turned On and Off simultaneously using the On and Off hard keys at the left side of the display.

Figure 117. Setpoint

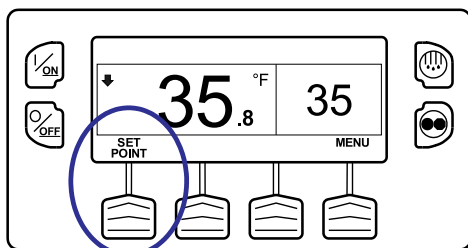

AMA1705

Select Temperature Units

If this feature enabled in Guarded Access > Main Menu Configuration, the operator can select temperature units to be displayed as either degrees Fahrenheit or degrees Celsius. From the Main Menu > Change Mode Menu choose Fahrenheit or Celsius and press the SELECT Soft Key (Figure 118, p. 100).

Figure 118. Fahrenheit or Celsius, Select Key

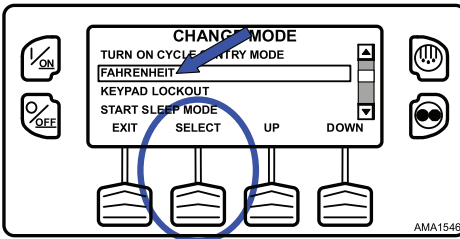

Choose the desired Temperature Units using the UP and DOWN Soft Keys and press the SELECT Soft Key to select the choice (Figure 119, p. 100).

Figure 119. Up, Down, Select Keys

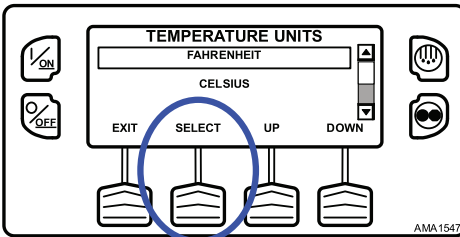

Temperatures will be displayed in the selected units.

- To leave this menu without changing the setting, press the EXIT Soft Key. To return to the Standard Display, press the EXIT Soft Key again.

Keypad Lockout

If enabled in Guarded Access > Main Menu Configuration, the keypad can be locked to prevent unauthorized use. If the keypad is locked, only the On Key and Off Key function. The keypad will remain locked even if the unit is turned off and back on. If Keypad Lockout is active, press and hold any soft key for five seconds to deactivate the feature. To turn the feature on, from the

Change Mode Menu choose Keypad Lockout and press the SELECT Soft Key (Figure 120, p. 101).

Figure 120. Select Key

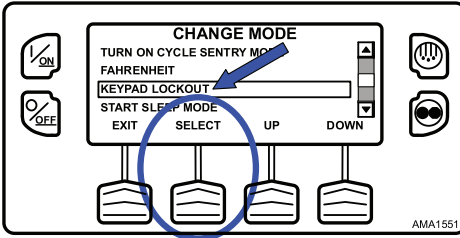

A Confirmation Request will appear. To activate Keypad Lockout press the YES Soft Key. To leave this menu without turning the Keypad Lockout feature on, press the NO Soft Key (Figure 121, p. 101).

Figure 121. Yes, No Soft Keys

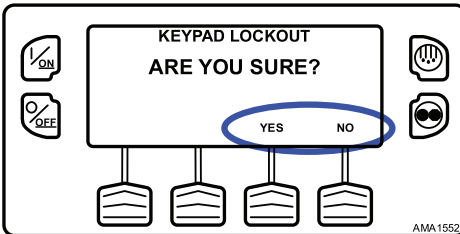

If the YES Soft Key was pressed, Keypad Lockout is active.

- If the keypad is locked, only the On Key and Off Key function. The keypad will remain locked even if the unit is turned off and back on.
- If Keypad Lockout is active, press and hold any soft key for five seconds to deactivate the feature.
- To return to the Standard Display, press the EXIT Soft Key again.

Start Sleep Mode

If this feature enabled in Guarded Access > Main Menu Configuration, the operator can select and set Sleep Mode from the Mode Menu. Sleep Mode is used to keep the engine warm and the battery charged when the unit is not in use. When the unit is Sleep Mode, the display will show “SLEEP” and the

Operating Instructions

current time. To turn the feature on, from the Change Mode Menu choose Start Sleep Mode and press the SELECT Soft Key (Figure 122, p. 102).

Figure 122. Select Soft Key

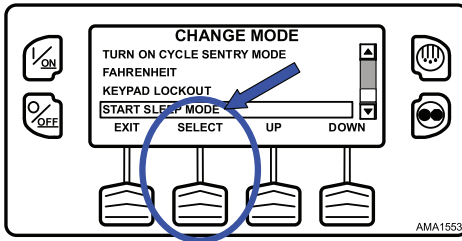

The following features are available in Sleep Mode. Follow the display prompts to select and set the features.

- **Program Wakeup Time:** This feature allows a wakeup time to be specified. When the selected time is reached, the unit will start and resume normal operation. If a Wakeup Time is selected, the following features are available:
 - Day to Wake Up: This feature allows the day the unit is to wake up to be specified.
 - Hour to Wake Up: This feature allows the hour the unit is to wake up to be specified.
 - Minute to Wake Up: This feature allows the minute the unit is to wake up to be specified.
 - Run Pretrip on Wakeup: This feature allows a Pretrip Test to be automatically run when the unit wakes up.

SmartPower™ Electric Standby Option

The Diesel/Electric Standby selection from the Main Menu allows the operator to manually select diesel or electric mode operation on units equipped with the electric standby SmartPower option. The unit can also be programmed to automatically switch to Electric Mode operation when standby power is available and to automatically switch to Diesel Mode operation if standby power fails or is removed. If the unit is programmed to automatically switch from diesel to electric and/or electric to diesel, the associated screens do not appear.

- If the unit is currently operating in Diesel Mode, the ELECTRIC STANDBY selection will appear in the Main Menu.

- If the unit is currently operating in Electric Mode, the DIESEL MODE selection will appear in the Main Menu.

Electric Mode Operation

If a unit equipped with the electric standby SmartPower option is running in Diesel Mode, the Diesel to Electric Auto-Switch feature is set NO and the unit is connected to a source of standby power, this feature allows the operator to manually select electric mode operation. This feature does not appear if the electric standby SmartPower option is not installed or if the Diesel to Electric Auto-Switch feature is set YES.

Diesel Mode Operation

If a unit equipped with the electric standby SmartPower option is running in Electric Mode and the Electric to Diesel Auto-Switch feature is set NO, this feature allows the operator to manually select diesel mode operation. This feature does not appear if the electric standby SmartPower option is not installed or if the Electric to Diesel Auto-Switch feature is set YES.

Switching from Diesel to Electric

If the unit is running in Diesel Mode and the Diesel to Electric Auto-Switch Enabled feature in Guarded Access is set YES, the unit will automatically switch to Electric Mode operation when standby power is connected and available. The screens shown (Figure 123, p. 103) (Figure 124, p. 104) will not appear.

If the unit is running in Diesel Mode and the Diesel to Electric Auto-Switch Enabled feature in Guarded Access is set NO, the unit can be switched to Electric Mode using the Electric Standby selection from the Main Menu.

From the Standard Display, press the MENU Key.

Figure 123. Menu Key

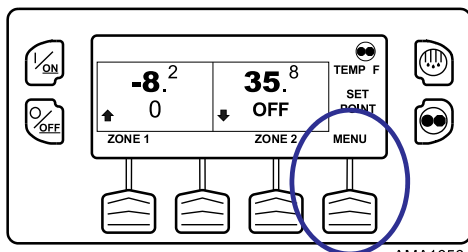

AMA1656

Operating Instructions

From the Main Menu, choose Electric Standby and press the SELECT Soft Key (Figure 124, p. 104).

Figure 124. Select Key

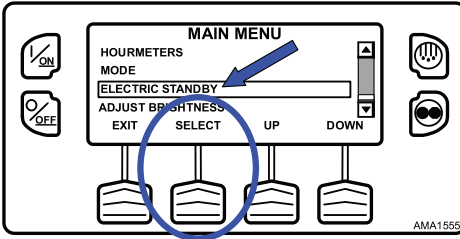

If the unit has standby power available and is turned on, the electric standby run screen will appear. The new mode is confirmed for 10 seconds. The unit will start and run in Electric Mode.

Any engine related Shutdown Alarms become Log Alarms when the unit is switched to Electric Mode operation. If the unit is switched back to Diesel Mode, these alarms again become Shutdown Alarms.

Electric Standby Power Fails or is Disconnected

If the electric standby power source fails or is disconnected and manual switching to Diesel Mode is selected, the unit will prompt for a switch to Diesel Mode (Figure 125, p. 104).

Figure 125. Diesel Mode Prompt

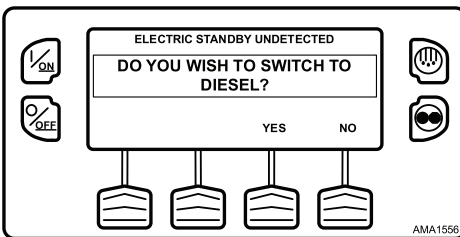

- Pressing the YES Soft Key will switch unit operation back to Diesel Mode.
- Pressing the NO Soft Key will allow the unit to remain in Electric Mode even though standby power is not available.

The unit will not run and Alarm Code 91 Check Electric Ready Input will be set as a Prevent Alarm.

Switching from Electric to Diesel

If the unit is running in Electric Mode and the Electric to Diesel Auto-Switch Enabled feature in Guarded Access is set YES, the unit will automatically switch to Diesel Mode operation when standby power is no longer available. The screens shown will not appear.

If the unit is running in Electric Mode and the Electric to Diesel Auto-Switch Enabled feature in Guarded Access is set NO and standby power is disconnected or fails, the unit will not automatically switch to Diesel mode. This is primarily designed to prevent unauthorized diesel engine starts when the truck is indoors or on a ferry where engine operation is strictly prohibited.

From the Standard Display, press the MENU Key (Figure 126, p. 105).

Figure 126. Menu Key

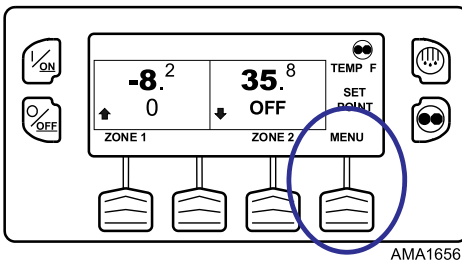

From the Main Menu, choose Diesel Mode and press the SELECT Soft Key (Figure 127, p. 105).

Figure 127. Select Key

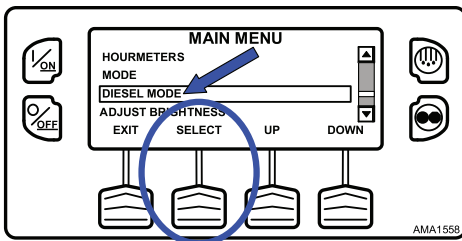

The new mode is confirmed for 10 seconds. The unit will start and run in Diesel Mode.

Operating Instructions

Any electric standby related Shutdown Alarms become Log Alarms when the unit is switched to Diesel Mode operation. If the unit is switched back to Electric Mode, these alarms again become Shutdown Alarms.

Adjust Brightness

The brightness of the HMI Control Panel display can be adjusted to allow for changing ambient light conditions. The choices available to the operator are HIGH, MEDIUM, LOW, and OFF. OFF actually results in a very dim screen suitable for low light conditions.

Display brightness is adjusted using the Adjust Brightness Menu. From the Standard Display, press the MENU Key (Figure 128, p. 106).

Figure 128. Menu Key

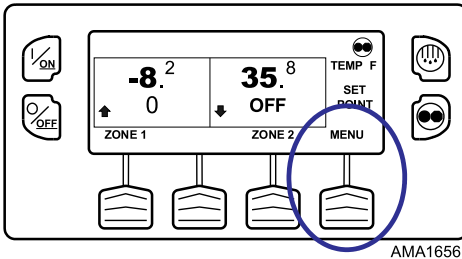

The Main Menu will appear. Press the UP or DOWN Key as required to choose the Adjust Brightness Menu. When the Adjust Brightness is selected, press the SELECT Key to choose the Adjust Brightness (Figure 129, p. 106).

Figure 129. Select Key

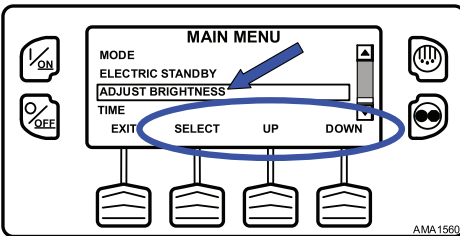

The Display Brightness menu will appear as shown. Press the UP or DOWN Soft Keys to select the desired display brightness. When the desired brightness is shown, press the SELECT Soft Key to confirm the choice (Figure 130, p. 107).

Figure 130. Select Key

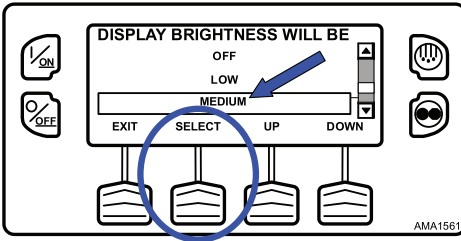

To return to the Main Menu, press the EXIT Key. To return to the Standard Display, press the EXIT Key again.

Time

The Time and Date held by the HMI Control Panel can be checked. Time and Date cannot be changed from the Main Menu. The time and date is accessed using the Main Menu. From the Standard Display, press the MENU Key (Figure 131, p. 107).

Figure 131. Menu Key

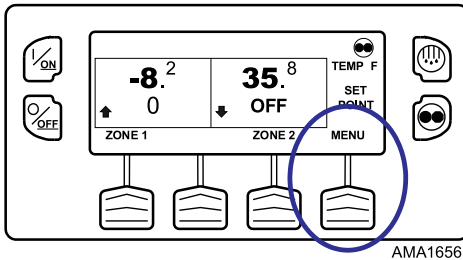

The Main Menu will appear. Press the UP or DOWN Key as required to choose the Time Menu. When the Time Menu is selected, press the SELECT Key to choose the Time Menu (Figure 132, p. 108).

Figure 132. Select Key

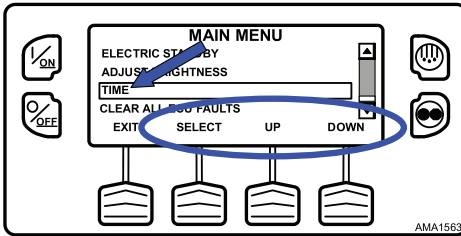

The date and time held in the HMI Control Panel will be shown on the display (Figure 133, p. 108). Time and Date cannot be changed from the Main Menu.

Figure 133. Date and Time

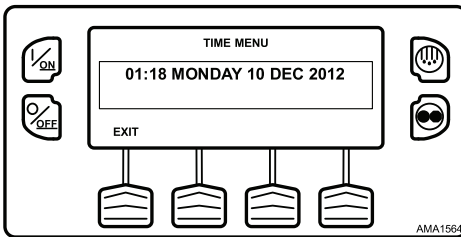

To return to the Main Menu, press the EXIT Key. To return to the Standard Display, press the EXIT Key again.

Clear All ECU Faults

Pressing this key will clear all existing Engine Control Unit (ECU) Fault Codes. This may allow continued unit operation should an ECU fault code result in engine shutdown.

- Any Thermo King Alarm Codes associated with the Engine Control Unit (ECU) Fault Codes will also be cleared.
- The Thermo King Alarm Codes and ECU Fault Codes that were cleared can be viewed in the ServiceWatch and ECU Data Loggers.

Engine Control Unit (ECU) Fault Codes are cleared using the Clear All ECU Faults Menu. From the Standard Display, press the MENU Key (Figure 134, p. 109).

Figure 134. Menu Key

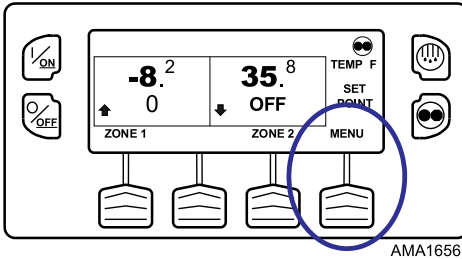

The Main Menu will appear. Press the UP or DOWN Key as required to choose the Clear All ECU Faults Menu. When the Clear All ECU Faults Menu is selected, press the SELECT Key to choose the Clear All ECU Faults Menu (Figure 135, p. 109).

Figure 135. Select Key

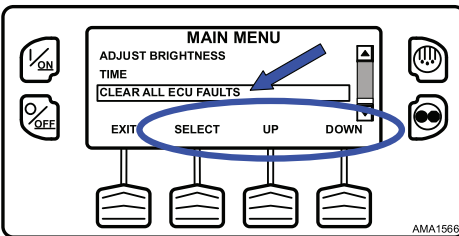

The Clear All ECU Faults Prompt will appear. To clear all ECU Faults and associated Thermo King Faults, press the CLEAR Soft Key (Figure 136, p. 109).

Figure 136. Clear Key

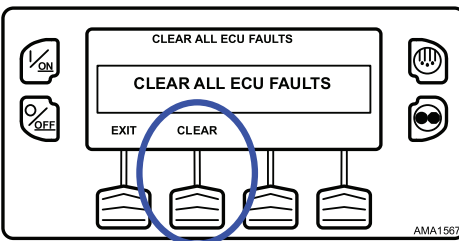

All ECU Faults and associated Thermo King Faults will be cleared.



Operating Instructions

To return to the Main Menu, press the EXIT Key. To return to the Standard Display, press the EXIT Key again.

Alarm Codes

Introduction

An alarm code is generated when the microprocessor senses an abnormal condition. Alarms direct an operator or service technician to the source of a problem.

Multiple alarms can be present at one time. All generated alarms will be stored in memory until cleared by the operator. Document all alarm occurrences and report them to the service technician.

See “Alarms Menu” in the Operator’s Instructions Chapter for information about viewing and clearing alarms.

Important: *Always record any Alarm Codes that occur in the order that they occur – as well as any other pertinent information. This information is extremely valuable to service personnel.*

Notes:

1. *Some alarms (3, 4, 74, 203, and 204) cannot be cleared in the Alarms Menu, they must be cleared in the Maintenance Menu or the Guarded Access Menu. Contact your supervisor or a Thermo King dealer about clearing those alarms.*
2. *In some cases alarms cannot be cleared, or cannot be cleared after they have occurred a specified number of times. If such is the case, these alarms must be cleared by a service technician.*

Alarm Types

There are four types of alarms.

Log Alarms

Log Alarms are indicated for 30 seconds each time the unit is turned on. This level of alarm serves as a notice to take corrective action before a problem becomes severe. Maintenance items such as maintenance hourmeter time-outs are Log Alarms. The TemperatureWatch™ screen is not disabled if only Log Alarm(s) are active.

When the unit is turned on, the display will show the Thermo King Logo and then the “Configuring System” message. If Log Alarm(s) are present, the Log Alarm notice will appear on the display for 30 seconds. The remote indicator alarm light (if installed) will also be on during this period. After 30

Alarm Codes

seconds, the Standard Display will appear and the remote indicator alarm light will go off.

Note: The Alarm Icon does not appear on startup with Log Alarms present.

Figure 137. Log Alarms Screen

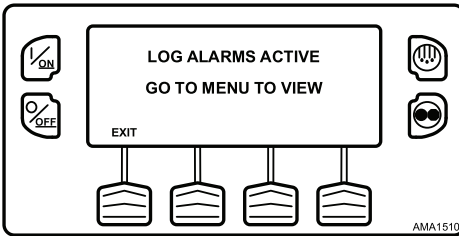

Check Alarms

Check Alarms are indicated by a steady alarm indication at the top of the display and the message “Service Required within 24 Hours”. The Alarm Icon will appear. This level of alarm serves as a notice to take corrective action before a problem becomes severe. The unit will run with Check Alarms but some features and functions may be inhibited. The TemperatureWatch screen is disabled if a Check Alarm is active.

Figure 138. Alarm Display

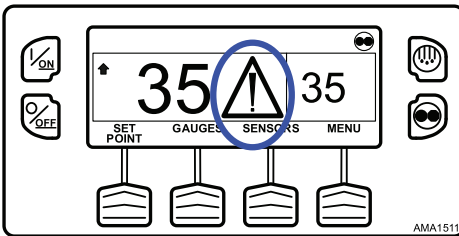

Unit Level Prevent Alarms

Prevent Alarms are indicated by a steady alarm indication.

- The alarm icon will appear.
- If installed, the optional remote indicator light will indicate an alarm condition exists.

-
- The unit may be temporarily shut down if a Prevent Alarm is active. The unit will remain shut down for a timed restart interval or until the fault conditions are corrected and then restart if necessary.
 - If the unit is in a temporary shutdown, Alarm Code 84 will be present along with the associated Prevent Alarm.
 - In some cases, the unit will restart with reduced performance to determine if continued operation is possible.
 - If the unit is operating with reduced performance, Alarm Code 85 may also be present.

If the alarm does not reoccur with reduced performance, the unit will return to full performance. In general, if the alarm condition occurs a specified number of times in a specified time interval, the alarm is set as a Shutdown Alarm and no further restarts are possible.

Note: *If the Restart After Shutdown feature in the Guarded Access Menu is set for CONTINUOUS, an unlimited number of restart attempts are allowed.*

Zone Specific Prevent Alarms

A zone specific Prevent Alarm will force the affected zone into a temporary shutdown, but allow the unit to continue to run as required by the host unit or other zones.

- A small alarm icon will appear next to the affected zone.
- If installed, the optional remote indicator light will indicate an alarm condition exists.
- If zone specific Prevent Alarms occur in all zones, the unit will be forced into a unit level prevent shut down.
- The TemperatureWatch screen is disabled any time a zone specific Prevent Alarm is active.

Unit Level Shutdown Alarms

Shutdown Alarms are indicated by all of the following:

- The unit will be shut down.
- The alarm icon will appear.
- The display and backlight will flash on and off.
- The display will switch from normal to inverted and back (light areas become dark and dark areas become light.)

Alarm Codes

- If installed, the optional remote indicator light will indicate an alarm condition exists.

Unit level Shutdown Alarms will force the unit into shutdown. The unit will remain in shutdown until the Shutdown Alarm is manually cleared. Exceptions are some engine and electric Shutdown Alarms that become Log Alarms when switched to the alternate operating mode (diesel to electric or electric to diesel). The TemperatureWatch screen is disabled any time a unit level Shutdown Alarm is active.

Zone Specific Shutdown Alarms

A zone specific Shutdown Alarm will force the affected zone to shut down, but allow the unit to continue to run as required by the host unit or other zones.

- A small alarm icon will appear next to the affected zone and blink with a period of ½ second on - ½ second off.
- If zone specific Shutdown Alarms occur in all zones, the unit will shut down and Alarm Code 114 will be set.
- If installed, the optional remote indicator light will indicate an alarm condition exists.

Pretrip Alarm Codes

If an alarm occurs during a Pretrip Test the alarm code will be displayed as Pretrip Alarm XX, where XX is the alarm code.

Clearing Alarm Codes

Most alarm codes can be cleared conventionally from the Alarm Menu using the CLEAR soft key. See the Operating Instructions chapter for procedures. The operator should contact a supervisor or a Thermo King dealer about clearing alarms using the Guarded Access Menu. Refer to (Table 1, p. 115) for alarm corrective action.

Note: Document all alarm faults and report them to the service technician.

There are three levels of corrective action that can be taken when an alarm condition occurs.

OK to Run: An alarm condition exists but does not affect unit operation. Corrective action can occur at a later date.

Check As Specified: An alarm condition exists that could affect unit operation. Follow directions in the Corrective Action column on the following chart.

Take Immediate Action: An alarm condition exists that will damage the unit or load. Take immediate action to correct the problem.

Note: *The corrective actions listed in the Operating Instructions chapter and in Table 1, p. 115 are suggestions only. Always consult your company for final decisions.*

Note: *Table 1, p. 115 shows all possible alarm codes for all possible applications. Not all codes will be applicable to each individual unit. Not all alarm codes are available with all microprocessor controllers or all revisions of software.*

Table 1. Table of Alarm Codes

COLOR CODE DEFINITIONS:		OK TO RUN	CHECK AS SPECIFIED	TAKE IMMEDIATE ACTION
Num	Description	Operator Action		
00	No Alarms Exist			No action required.
02	Check Evaporator Coil Sensor			Manually monitor load temperature. Report alarm at end of day.
03	Check (Control) Return Air Sensor			Manually monitor load temperature. Report alarm at end of day.
04	Check (Control) Discharge Air Sensor			Manually monitor load temperature. Report alarm at end of day.
05	Check Ambient Temp Sensor			Report alarm at end of day.
06	Check Coolant Temp Sensor			Report alarm at end of day.
07	Check Engine RPM Sensor			Report alarm at end of day.
(09)	High Evaporator Temperature			Manually monitor load temperature. Report alarm at end of day.
(10)	High Discharge Pressure			If unit is shut down repair immediately. Otherwise, report alarm at end of day.
11	Unit Controlling on Alternate Sensor			Manually monitor load temperature. Report alarm at end of day.
12	Sensor or Digital Input Shutdown			The unit is no longer able to operate and has been shut down. Repair immediately.
13	Sensor Calibration Check			Manually monitor load temperature. Report alarm at end of day.

Alarm Codes

Table 1. Table of Alarm Codes (continued)

COLOR CODE DEFINITIONS:		OK TO RUN	CHECK AS SPECIFIED	TAKE IMMEDIATE ACTION
Num	Description	Operator Action		
(17)	Engine Failed to Crank			If unit is shut down repair immediately. Otherwise, report alarm at end of day.
(18)	High Engine Coolant Temperature			If unit is shut down repair immediately. Otherwise, report alarm at end of day.
(19)	Low Engine Oil Pressure			If unit is shut down repair immediately. Otherwise, report alarm at end of day.
(20)	Engine Failed to Start			If unit is shut down repair immediately. Otherwise, report alarm at end of day.
(21)	Cooling Cycle Check			Manually monitor load temperature. Report alarm at end of day.
(22)	Heating Cycle Check			Manually monitor load temperature. Report alarm at end of day.
(23)	Cooling Cycle Fault			The unit is no longer able to operate and has been shut down. Repair immediately.
(24)	Heating Cycle Fault			The unit is no longer able to operate and has been shut down. Repair immediately.
25	Alternator/Battery Charger Check			If unit is shut down repair immediately. Otherwise, report alarm at end of day.
(26)	Check Refrigeration Capacity			Manually monitor load temperature. Report alarm at end of day.
28	Pretrip Abort			Report alarm at end of day.
31	Check Oil Pressure Switch			If unit is shut down repair immediately. Otherwise, report alarm at end of day.
32	Refrigeration Capacity Low			The unit is no longer able to operate and has been shut down. Repair immediately.

Table 1. Table of Alarm Codes (continued)

COLOR CODE DEFINITIONS:		OK TO RUN	CHECK AS SPECIFIED	TAKE IMMEDIATE ACTION
Num	Description	Operator Action		
33	Check Engine RPM			Report alarm at end of day.
35	Check Run Relay Circuit			If unit is shut down repair immediately. Otherwise, report alarm at end of day.
(36)	Electric Motor Failed to Run			If unit is shut down repair immediately. Otherwise, report alarm at end of day.
37	Check Engine Coolant Level			Check engine coolant level. <u>Do not remove the cap if the engine is hot.</u> Report alarm at end of day.
38	Electric Phase Reversed			If unit is shut down repair immediately. Otherwise, report alarm at end of day.
39	Check Water Valve Circuit			If unit is shut down repair immediately. Otherwise, report alarm at end of day.
40	Check High Speed Circuit			If unit is shut down repair immediately. Otherwise, report alarm at end of day.
41	Check Engine Coolant Temperature			If unit is shut down repair immediately. Otherwise, report alarm at end of day.
42	Unit Forced to Low Speed			Report alarm at end of day.
43	Unit Forced to Low Speed Modulation			Report alarm at end of day.
44	Check Fuel System			Add fuel as necessary, otherwise report alarm at end of day.
45	Check Hot Gas or Hot Gas Bypass Circuit			If unit is shut down repair immediately. Otherwise, report alarm at end of day.
46	Check Air Flow			If unit is shut down repair immediately. Otherwise, report alarm at end of day.

Alarm Codes

Table 1. Table of Alarm Codes (continued)

COLOR CODE DEFINITIONS:		OK TO RUN	CHECK AS SPECIFIED	TAKE IMMEDIATE ACTION
Num	Description	Operator Action		
48	Check Belts or Clutch			If unit is shut down repair immediately. Otherwise, report alarm at end of day.
50	Reset Clock			Report alarm at end of day.
52	Check Heat Circuit			If unit is shut down repair immediately. Otherwise, report alarm at end of day.
54	Test Mode Timeout			Service Test or Output Test timed out after 15 minutes. Report alarm at end of day.
56	Check Host Evap Fan Low Speed			If unit is shut down repair immediately. Otherwise, report alarm at end of day.
57	Check Host Evap Fan High Speed			If unit is shut down repair immediately. Otherwise, report alarm at end of day.
61	Low Battery Voltage			If unit is shut down repair immediately. Otherwise, report alarm at end of day.
62	Ammeter Out of Calibration			If unit is shut down repair immediately. Otherwise, report alarm at end of day.
(63)	Engine Stopped			If unit is shut down repair immediately. Otherwise, report alarm at end of day.
64	Pretrip Reminder			Report alarm at end of day.
65	Abnormal Temperature Differential			Report alarm at end of day.
66	Low Engine Oil Level			Check engine oil level. If unit is shut down repair immediately. Otherwise, report alarm at end of day.
67	Check Liquid Line Solenoid Circuit			If unit is shut down repair immediately. Otherwise, report alarm at end of day.

Table 1. Table of Alarm Codes (continued)

COLOR CODE DEFINITIONS:		OK TO RUN	CHECK AS SPECIFIED	TAKE IMMEDIATE ACTION
Num	Description	Operator Action		
68	Internal Controller Fault Code			Report alarm at end of day.
70	Hourmeter Failure			Report alarm at end of day.
74	Controller Reset to Defaults			Report alarm at end of day.
79	Internal Data Logger Overflow			Report alarm at end of day.
84	Restart Null			Report alarm at end of day.
85	Forced Unit Operation			Report alarm at end of day.
86	Check Discharge Pressure Sensor			Report alarm at end of day.
87	Check Suction Pressure Sensor			Report alarm at end of day.
89	Check Electronic Throttling Valve Circuit			If unit is shut down repair immediately. Otherwise, report alarm at end of day.
90	Electric Overload			If unit is shut down repair immediately. Otherwise, report alarm at end of day.
91	Check Electric Ready Input			If unit is shut down repair immediately. Otherwise, report alarm at end of day.
92	Sensor Grades Not Set			Report alarm at end of day.
96	Low Fuel Level			Check engine fuel level and add fuel as required.
98	Check Fuel Level Sensor			Report alarm at end of day.
108	Door Open Time-out			Close doors. Report alarm at end of day.
111	Unit Not Configured Correctly			Report alarm at end of day.
113	Check Electric Heat Circuit			If unit is shut down repair immediately. Otherwise, report alarm at end of day.
114	Multiple Alarms - Can Not Run			If unit is shut down repair immediately. Otherwise, report alarm at end of day.

Alarm Codes

Table 1. Table of Alarm Codes (continued)

COLOR CODE DEFINITIONS:		OK TO RUN	CHECK AS SPECIFIED	TAKE IMMEDIATE ACTION
Num	Description	Operator Action		
117	Auto Switch from Diesel to Electric			Report alarm at end of day.
118	Auto Switch from Electric to Diesel			Report alarm at end of day.
120	Check Alternator Excite Circuit			If unit is shut down repair immediately. Otherwise, report alarm at end of day.
121	Check PWM/Liquid Injection Circuit			If unit is shut down repair immediately. Otherwise, report alarm at end of day.
122	Check Diesel/Electric Circuit			If unit is shut down repair immediately. Otherwise, report alarm at end of day.
127	Setpoint Not Entered			Be sure setpoint is adjusted to required temperature.
128	Engine Run Time Maintenance Reminder # 1			Report alarm at end of day.
129	Engine Run Time Maintenance Reminder # 2			Report alarm at end of day.
130	Electric Run Time Maintenance Reminder # 1			Report alarm at end of day.
131	Electric Run Time Maintenance Reminder # 2			Report alarm at end of day.
132	Total Unit Run Time Maintenance Reminder # 1			Report alarm at end of day.
133	Total Unit Run Time Maintenance Reminder # 2			Report alarm at end of day.
134	Controller Power On Hours			Report alarm at end of day.
141	Auto-Switch Diesel to Electric Disabled			Report alarm at end of day.
143	Check Remote Zone Drain Hose Heater Output			If unit is shut down repair immediately. Otherwise, report alarm at end of day.

Table 1. Table of Alarm Codes (continued)

COLOR CODE DEFINITIONS:		OK TO RUN	CHECK AS SPECIFIED	TAKE IMMEDIATE ACTION
Num	Description	Operator Action		
144	Lost Expansion Module CAN Communication			If unit is shut down repair immediately. Otherwise, report alarm at end of day.
145	Loss of Controller "On" 8XP Feedback Signal			If unit is shut down repair immediately. Otherwise, report alarm at end of day.
146	Software Version Mismatch			If unit is shut down repair immediately. Otherwise, report alarm at end of day.
148	Auto-Switch Electric to Diesel Disabled			Report alarm at end of day.
150	Out of Range Low (HMI)			Manually monitor load temperature. Report alarm at end of day.
151	Out of Range High (HMI)			Manually monitor load temperature. Report alarm at end of day.
157	OptiSet File Mismatch			Report alarm at end of day.
158	Primary Software Failed to Load			Report alarm at end of day.
159	Check Battery Condition			If unit is shut down repair immediately. Otherwise, report alarm at end of day.
160	Lost Radio Expansion Board (REB) CAN Communication			If unit is shut down repair immediately. Otherwise, report alarm at end of day.
203	Check Display Return Air Sensor			Manually monitor load temperature. Report alarm at end of day.
204	Check Display Discharge Air Sensor			Manually monitor load temperature. Report alarm at end of day.
233	REB Transitioning From Conservative to Full Null			Report alarm at end of day.
234	Check Relative Humidity Sensor			Report alarm at end of day.
251	REB Mis-configured			Report alarm at end of day.
252	Check Auto Fresh Air Exchange			Report alarm at end of day.

Alarm Codes

Table 1. Table of Alarm Codes (continued)

COLOR CODE DEFINITIONS:		OK TO RUN	CHECK AS SPECIFIED	TAKE IMMEDIATE ACTION
Num	Description	Operator Action		
508	Speed Request Communications Error			Report alarm at end of day.
509	Engine Control Unit (ECU) Failed to Enable			If unit is shut down repair immediately. Otherwise, report alarm at end of day.
510	Engine Control Unit (ECU) Run Signal Failed			If unit is shut down repair immediately. Otherwise, report alarm at end of day.
511	Engine Wait to Start Time Delay Expired			Report alarm at end of day.
517	Water in Fuel			Report alarm at end of day.
518	Generator Ground Fault			If unit is shut down repair immediately. Otherwise, report alarm at end of day.
519	Check Battery Charger Input Power			If unit is shut down repair immediately. Otherwise, report alarm at end of day.
520	Check Battery Charger Output Power			If unit is shut down repair immediately. Otherwise, report alarm at end of day.
521	Battery Charger External / Environmental Faults			If unit is shut down repair immediately. Otherwise, report alarm at end of day.
522	Battery Temperature Sensor Alarm			If unit is shut down repair immediately. Otherwise, report alarm at end of day.
523	Battery Charger Indicated Conditions			If unit is shut down repair immediately. Otherwise, report alarm at end of day.
524	Generator Operational Limit, V out to Frequency Ratio			If unit is shut down repair immediately. Otherwise, report alarm at end of day.
525	Generator Frequency Range Fault			If unit is shut down repair immediately. Otherwise, report alarm at end of day.

Table 1. Table of Alarm Codes (continued)

COLOR CODE DEFINITIONS:		OK TO RUN	CHECK AS SPECIFIED	TAKE IMMEDIATE ACTION
Num	Description	Operator Action		
526	Generator Operational Limit Output Current	If unit is shut down repair immediately. Otherwise, report alarm at end of day.		
528	Controller Not Receiving Messages From Battery Charger	If unit is shut down repair immediately. Otherwise, report alarm at end of day.		
529	Check Fuel Pump Circuit	If unit is shut down repair immediately. Otherwise, report alarm at end of day.		
538	Engine J1939 CAN Datalink Degraded (Electronic Engine Only)	If unit is shut down repair immediately. Otherwise, report alarm at end of day.		
539	Engine J1939 CAN Datalink Failed (Electronic Engine Only)	If unit is shut down repair immediately. Otherwise, report alarm at end of day.		
599	Engine Service Tool Connected	Maintenance information only. Report alarm at end of the day.		
600	Check Crankshaft Speed Sensor	Report alarm at end of day.		
601	Check Camshaft Speed Sensor	Report alarm at end of day.		
602	Check Intake Throttle Position Sensor	Report alarm at end of day.		
603	Check Exhaust Pressure Sensor	Report alarm at end of day.		
604	Check Coolant Temperature Sensor	Report alarm at end of day.		
605	Check Fresh Air Temperature Sensor	Report alarm at end of day.		
607	Check Fuel Temperature Sensor	Report alarm at end of day.		
608	Check Rail Pressure Sensor	Report alarm at end of day.		
609	Check Intake Pressure Sensor	Report alarm at end of day.		
610	Check Atmospheric Pressure Sensor	Report alarm at end of day.		
611	Check Glow Plug Circuit	Report alarm at end of day.		

Alarm Codes

Table 1. Table of Alarm Codes (continued)

COLOR CODE DEFINITIONS:		OK TO RUN	CHECK AS SPECIFIED	TAKE IMMEDIATE ACTION
Num	Description	Operator Action		
612	Check Intake Throttle Circuit			Report alarm at end of day.
613	Check Injector(s)			Report alarm at end of day.
614	Check High Pressure Fuel Pump			Report alarm at end of day.
615	Rail Pressure Fault			If unit is shut down repair immediately. Otherwise, report alarm at end of day.
616	Engine Overspeed			If unit is shut down repair immediately. Otherwise, report alarm at end of day.
617	Internal ECU Fault			If unit is shut down repair immediately. Otherwise, report alarm at end of day.
618	Check EGR			Report alarm at end of day.
619	ECU Main Relay Fault			Report alarm at end of day.
623	TRU CAN Message Timeout			Report alarm at end of day.
624	Check EGR Temperature Sensor			Report alarm at end of day.
625	Check Intake Air Temperature Sensor			Report alarm at end of day.
626	Check Exhaust Temperature Sensor			Report alarm at end of day.
699	Unknown ECU Fault			If unit is shut down repair immediately. Otherwise, report alarm at end of day.

Loading and Inspection Procedures

This chapter describes pre-loading inspections, loading procedures, post-loading procedures, post-loading inspections, and enroute inspections. Thermo King refrigeration units are designed to maintain the required product load temperature during transit. Follow these recommended loading and enroute procedures to help minimize temperature related problems.

Note: *When in doubt as to the correct refrigeration requirements and/or loading procedures, call your company office for instructions.*

Pre-Loading Inspection

NOTICE

Cargo Loss!

Cargo must be pre-cooled to the proper temperature before loading. The unit is designed to maintain temperature, not cool an above-temperature load.

NOTICE

Unit Damage!

Push the controller access door firmly closed after each use. Unit damage can occur in transit if the door is not properly closed.

1. Make sure the unit is turned off before opening the doors to minimize frost accumulation on the evaporator coil and heat gain in the trailer. (Unit may be running when loading the trailer from a warehouse with door seals.)
2. Spot check and record load temperature while loading. Especially note any off-temperature product.
3. Load the product so that there is adequate space for air circulation completely around the load. DO NOT block the evaporator inlets or outlets.
4. Products should be pre-cooled before loading. Thermo King transport refrigeration units are designed to maintain loads at the temperature at which they were loaded. Transport refrigeration units are not designed to pull hot loads down to temperature. Verify that the setpoint temperatures are correct for your cargo. Pre-cool the trailer as required.

Figure 139. Multi-Temperature Loading Considerations

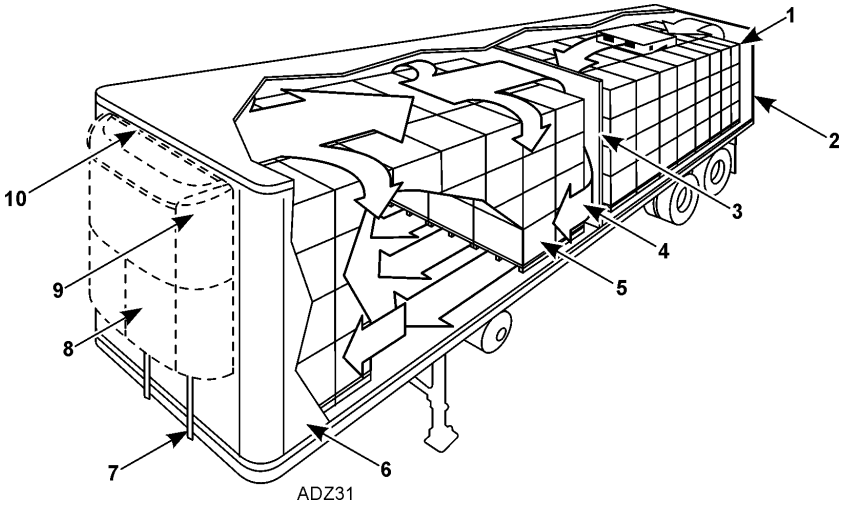

1.	Correct load height (trailers without chutes)	6.	Interior/exterior walls and insulation in good condition
2.	Tight doors and gaskets	7.	Clear defrost drains
3.	Center bulkhead with tight air seals (multiple compartment trailers)	8.	Unit inspection
4.	Good air circulation around load	9.	Good outside air circulation
5.	Proper cargo temperature prior to loading	10.	Tight air seals between unit and trailer

Single Temperature Loading Procedures

Additional steps must be taken to insure load temperature requirements are implemented and maintained when a multi-temp unit is used to refrigerate a single-temperature load. Trailer loading procedure will be different depending on how temperature control has established for each trailer compartment Zone. Refer to ([“Operating the Unit in Single Zone Control Mode,” p. 45](#)) in the Operating Instructions chapter in this manual.

In the example ([Figure 140, p. 127](#)), each Zone could be individually set to 35°F. The evaporator in each compartment will then control the temperature in that compartment to the same 35°F setpoint.

Loading and Inspection Procedures

Note: Using the above method, it is recommended that the bulkheads that separate each compartment be in place to isolate the compartments.

Figure 141, p. 127 shows two Zones that have the same setpoint. The bulkhead separating the compartments has been removed. The Host evaporator senses temperature and controls both evaporators to the temperature setpoint.

Note: Using Method 2, it is recommended that all bulkheads be removed to create one large compartment.

Figure 140. Two Compartments, Same Setpoint Temperature, Bulkheads In Place

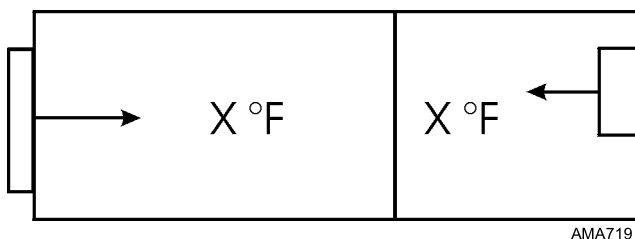
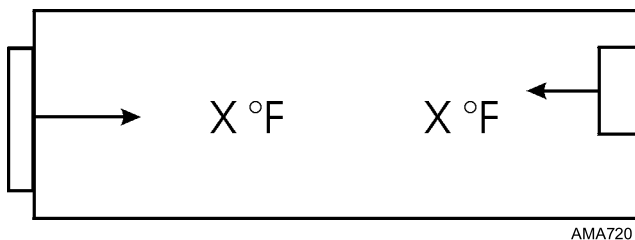

Figure 141. Two Compartments, Same Setpoint Temperature, Bulkhead(s) Removed



Post-Loading Inspection

1. Make sure all the doors are closed and locked.
2. Start the unit if it was shut off to load.
3. Make sure the setpoints are at the desired settings.
4. One-half hour after loading, manually initiate a Defrost cycle. If the evaporator coil sensor temperature is below 45 F (7 C), the unit will Defrost. The microprocessor will terminate Defrost automatically when the evaporator coil temperature reaches 58 F (14.5 C) or the unit has been

Loading and Inspection Procedures

in the Defrost mode for 30 or 45 minutes (depending on setting).

Post Trip Checks

1. Wash the unit.
2. Check for leaks.
3. Check for loose or missing hardware.
4. Check for physical damage to the unit.

Enroute Inspections

Complete the following enroute inspection every four hours. This will help minimize temperature related problems.

Inspection Procedure

1. Verify setpoint is correct.
2. Check the return air temperature reading. It should be within the desired temperature range.
3. Initiate a manual defrost cycle after each enroute inspection.

Inspection Troubleshooting

1. If a temperature reading is not within the desired temperature range, refer to the troubleshooting table ([Table 2, p. 129](#)). Correct problem as required.
2. Repeat the Enroute Inspection every 30 minutes until the compartment temperature is within the desired temperature range. Stop the unit if the compartment temperature is not within the desired temperature range on two consecutive 30 minute inspections, especially if the compartment temperature appears to be moving away from the setpoint.
3. Immediately contact the nearest Thermo King Service Center or your company office.
4. Take all necessary steps to protect and maintain proper load temperature.

Loading and Inspection Procedures

NOTICE

Cargo Loss!

Stop the unit if the compartment temperature remains higher than the desired temperature range from the setpoint on two consecutive 30 minute inspections. Contact the nearest Thermo King Service Center or your company office immediately. Take all necessary steps to protect and maintain proper load temperature.

Table 2. Inspection Troubleshooting

Problem: A return air temperature reading is not within desired temperature range of the setpoint.	
Cause	Remedy
The unit has not had time to cool down to correct temperature.	Refer to the load log history. Look for above temperature load records, properly pre-cooled cargo compartment, length of time on road, etc. Correct as required. Continue monitoring return air temperature until the reading is within the desired temperature range of the setpoint.
The unit may have a low refrigerant charge.	Check the receiver tank sight glass for refrigerant level. If fluid is not showing in the receiver tank sight glass, the refrigerant charge may be low. A competent refrigeration technician is required to add refrigerant or repair the system. Contact the nearest Thermo King dealer, authorized Service Center, or call the Thermo King Cold Line for referral. Consult the Table of Contents for Cold Line information.
The unit is in defrost or has just completed a defrost cycle.	Monitor the return air temperature after the defrost cycle is completed to see if the temperature returns to the desired temperature range of the setpoint.
The evaporator is plugged with frost.	Initiate a manual defrost cycle. The defrost cycle will automatically terminate when complete. Continue monitoring the return air temperature until the reading is within the desired temperature range of the setpoint.
Improper air circulation in the cargo compartment.	Inspect the unit and cargo compartment to determine if the evaporator fan (3) are working properly circulation the air. Poor air circulation may be due to improper loading of the cargo, shifting of the load, or depending on unit, fan belt slippage or faulty electrical fans. Correct as required. Continue monitoring return air temperature until problem is corrected.

Loading and Inspection Procedures

Table 2. Inspection Troubleshooting (continued)

Problem: A return air temperature reading is not within desired temperature range of the setpoint.	
Cause	Remedy
The unit did not start automatically.	Determine the cause for not starting. Correct as required. Continue monitoring return air temperature until reading is within desired temperature range of the setpoint.
Multi-Temp Units Only – The unit is being used to cool/heat a single temperature load and does not have the capacity to cool the entire trailer.	A multi-temperature unit may not have the cooling or heating capacity to maintain a specific temperature range throughout an entire trailer.

Jump Starting

If unit battery is discharged or run down, unit may be jump started using jumper cables and another battery or vehicle. Consider the following precautions and be careful when jump starting a unit.

⚠ WARNING

Personal Protective Equipment (PPE) Required!

A battery can be dangerous. A battery contains a flammable gas that can ignite or explode. A battery stores enough electricity to burn you if it discharges quickly. A battery contains battery acid that can burn you. Always wear goggles or safety glasses and personal protective equipment when working with a battery. If you get battery acid on you, immediately flush it with water and get medical attention.

⚠ CAUTION

Hazard of Explosion!

Unhook the semi tractor from the trailer before using the tractor to jump start the unit on the trailer. The negative ground circuit is complete when the tractor is hooked to the trailer. This can cause dangerous sparks when the positive connection is made at the battery.

Important: *Make sure to use a 12 volt battery to jump start unit. If you are using a vehicle, make sure it has a 12 volt battery with a negative ground system. Do not use a "hot shot" booster device or a 24 volt source.*

Read and understand the following procedure completely before connecting and jumper cables. Use good jumper cables made with #2 gauge (or larger) cables.

1. Verify unit is turned off. If you are using a vehicle, verify its ignition is also turned off.
2. Open front doors on unit. Battery is located on the right of engine.
3. Check discharged battery to verify it is not damaged or frozen. Do not jump start a damaged or frozen battery. Check vent caps to verify they are tight.
4. Identify positive (+) and negative (-) battery terminals.
5. Remove red cover from positive (+) battery terminal on the unit's battery.

Figure 142. Sequence for Connecting Jumper Cables

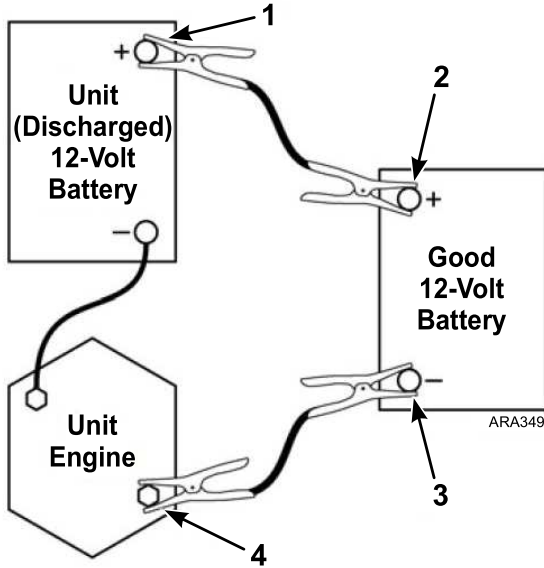

1.	Positive (+) Terminal on Unit Battery
2.	Positive (+) Terminal on Good Battery
3.	Negative (-) Terminal on Good Battery
4.	Starter Mounting Bolt on Unit Engine

6. Connect the red positive (+) jumper cable to the positive (+) battery terminal on the unit's battery. Do not let the other end of the jumper cable touch anything that conducts electricity.

⚠ WARNING

Hazard of Explosion!

Allowing the positive (+) jumper cable to short to ground can produce dangerous sparks.

7. Connect the other end of the red positive (+) jumper cable to the positive (+) battery terminal on the good battery.

8. Connect the black negative (-) jumper cable to the negative (-) battery terminal on a good battery. Do not let the other end of the jumper cable touch anything that conducts electricity.
9. Connect the black negative (-) jumper cable to the lower starter mounting bolt on the unit's engine.
10. If you are using a vehicle to jump start the unit, start the vehicle and let it run for a few minutes. This will help charge the discharged battery.

⚠ DANGER

Risk of Injury!

Keep your hands, clothing, and tools clear of fans and/or belts when working on a unit that is running or when opening or closing compressor service valves. Loose clothing might entangle moving pulleys or belts, causing serious injury or possible death.

11. Turn the unit on and let it start automatically or start it manually. If the unit will not crank or start, contact a qualified technician.
Note: Some units with microprocessors will show an alarm code and will not try to start the unit until battery voltage is above 10 volts.
12. After the unit starts, remove the jumper cables in reverse order: black negative (-) from the unit starter mounting bolt, black negative (-) from the good battery, red positive (+) from the good battery, and red positive (+) from the unit battery (that was discharged).

Figure 143. Sequence for Disconnecting Jumper Cables

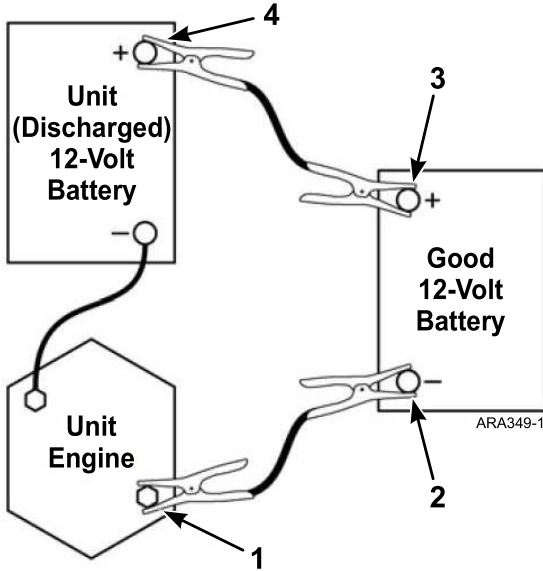

1.	Starter Mounting Bolt on Unit Engine
2.	Negative (-) Terminal on Good Battery
3.	Positive (+) Terminal on Good Battery
4.	Positive (+) Terminal on Unit Battery

Specifications

Engine

<p>Note: New diesel engine models started being installed in units beginning the 4th quarter of 2020. Some engine components along with maintenance and inspection procedures are different between engine models. Refer to the information located on top of the engine to determine which model engine is in your unit, or contact your Thermo King Dealer for assistance.</p>	
Model/Engine	<p>C-600M: TK486V25 changed to TK486V25L 4th quarter 2020, then to TK486V25L1 1st quarter 2021. S-610M/S-610DE: TK488CR changed to TK488CR1 2nd quarter 2021.</p>
Fuel Type	<p>TK486V25, TK486V25L and TK486V25L1: No. 2 diesel fuel under normal conditions No. 1 diesel fuel is acceptable cold weather fuel</p> <p>TK488CR and TK488CR1: *No. 2 diesel fuel under normal conditions *No. 1 diesel fuel is acceptable cold weather fuel * NOTE: The sulfur content must be less than or equal to 15 ppm, the fuel must be free of zinc, and comply with the latest release of ASTM D975, EN 590, or JIS K2204.</p>
Oil Capacity	12 quarts (11.4 liters) crankcase and oil filter.
Oil Type	<p>API Classification CJ-4 or CK-4. ACEA Rating E6</p> <p>Important: This oil type must be used together with ULSD fuel to prevent damage to the DOC.</p>
Oil Viscosity	<p>14 F to 122 F (-10 C to 50 C): SAE 15W-40 (Synthetic) 5 to 104 F (-15 to 40 C): SAE 15W-40 5 to 104 F (-15 to 40 C): SAE 10W-30 (Synthetic or Synthetic Blend) -13 to 104 F (-25 to 40 C): SAE 10W-40 -13 to 86 F (-25 to 30 C): SAE 10W-30 -22 to 122 F (-30 to 50 C): SAE 5W-40 (Synthetic) Below -22 F (-30 C): SAE 0W-30 (Synthetic)</p>
Engine Coolant Type	<p>Chevron/DeLo XLC - a nitrite-free Extended Life Coolant (ELC) Use a 50/50 concentration</p>

NOTICE

System Contamination!

Do not add "GREEN" or "BLUE-GREEN" conventional coolant to cooling systems using "RED" Extended Life Coolant, except in an emergency. If conventional coolant is added to Extended Life Coolant, the coolant must be changed after 2 years instead of 5 years.

Specifications

Coolant System Capacity	7.5 quarts (7.1 liters)
Radiator Cap Pressure	15 psig (103 kPa)
Engine Coolant Thermostat	160 F (71 C)

Refrigeration System

Contact your Thermo King dealer for refrigeration system service or maintenance.

Electrical Control System

Low Voltage	12.5 Vdc
High Voltage	<p>230 Vac from AC generator at engine low speed. 345 Vac from AC generator at engine high speed.</p> <div style="background-color: black; color: white; text-align: center; padding: 5px;">⚠ DANGER</div> <div style="border: 1px solid black; padding: 5px;"> <p>Hazardous Voltage!</p> <p>All inspection or service procedures of the high voltage systems should only be done by an authorized Thermo King dealer.</p> </div>
Battery	<p>One, Group C31, 12 volt battery. The battery must be suitable for deep cycling, heavy duty and rated with a minimum of 95 amp/hr. Thermo King ReliaMax 925N (925 CCA) wet cell battery is recommended for both warm and cold climates. Thermo King EON (1150 CCA) AGM battery is recommended for extreme climates and for Rail Ready (RR), Domestic Refrigerated Container (DRC), and Trailer on Flat Car (TOFC) applications.</p> <p>Note: <i>If the unit is not going to be used for an extended period of time, turn the Microprocessor On/Off Power Switch to the OFF position to maximize battery life.</i></p>
Fuses	Refer to Fuses ("Unit Protection Devices," p. 29).
Battery Charging	12 volt, 65 or 120 amp, brush type, Thermo King Alternator.

Electrical Standby (SmartPower Unit Only)

Note: A transformer is used to convert 460 Vac to 230 Vac in units configured to use electric standby input voltage of 460 Vac.

Electric Motor and Overload Relay

Voltage/ Phase/ Frequency	Horse- power	Kilowatts	RPM	Full Load (amps)	Overload Relay Setting (amps)
230/3/60	12.0	9.0	1760	31.2	34
460/3/60	12.0	9.0	1760	15.6	20
460/3/60	19.0	14.2	3500	21.7	32

Standby Power Cord Requirements (SmartPower Units Only)

Supply Circuit Breaker	230/3/60 (12 hp motor) – 50 amps (1) 460/3/60 (12 hp motor) – 30 amps (1) 460/3/60 (15/16 hp motor) – 30 amps (1) 460/3/60 (19 hp motor) – 50 amps (1)
Extension Cord Size	230/3/60 (12 hp motor) – Type W, 8 AWG (2) 460/3/60 (12 hp motor) – Type W or SOOW, 10 AWG (2) 460/3/60 (15/16 hp motor) – Type W or SOOW, 10 AWG (2) 60/3/60 (19 hp motor) – Type W, 8 AWG Power Cable (2)
(1) HACR/Motor Circuit Breaker Recommended, Consult a Licensed Electrician (2) 25 ft (7.5m) permitted without cable management, 75 ft. (22.8 m) Max recommended permitted with approved cable management system	

Maintenance Inspection Schedule

Host Unit

Note: Pretrip inspections can be performed by the operator. 1,500, 3,000, and 4,500 hours/annual inspections should be performed by an authorized Thermo King dealer.

Pretrip	Every 1,500 Hours	Every 3,000 Hours*	Annual / 4,500 Hours	As Needed	Inspect/Check/Service These Items
					Microprocessor:
•					Run Pretrip Test.
					Engine:
•					Check fuel supply.
•					Check engine oil level.
•	•	•	•		Inspect belts for condition and proper tension.
•	•	•	•		Check engine oil pressure hot, on high speed (should display "OK").
•	•	•	•		Listen for unusual noises, vibrations, etc.
•	•	•	•		Check engine coolant level and antifreeze protection (-30 F [-40 C]).
	•	•	•		Drain water from fuel tank and check vent.
	•	•	•		Inspect/clean electric fuel pump filter
	•	•	•		TK486V25L and TK486V25L1 Engines Only: Check and adjust engine speeds (high and low speed).

Maintenance Inspection Schedule

Pretrip	Every 1,500 Hours	Every 3,000 Hours*	Annual/ 4,500 Hours	As Needed	
Inspect/Check/Service These Items					
	•	•	•		Check condition of drive coupling bushings per Service Bulletin TT171.
			•		Check engine mounts for wear.
		•			TK486V25L and TK486V25L1 Engines Only: Replace EMI 3000 air cleaner element (see "EMI 3000 Air Cleaner") at 3,000 hours or two years (whichever occurs first). See Note.
		•			TK486V25L and TK486V25L1 Engines Only: Replace EMI 3000 fuel filter/water separator.
		•			TK488CR Engines Only: Replace EMI 3000 fuel filter/water separator. See Note. TK488CR1 Engines Only: Replace the primary and secondary fuel filters. See Note.
				•	TK488CR1 Engines Only: Drain water separator as needed. Alarm Code 517 indicates water level high and separator needs draining.
		•			Change engine oil and oil filter (hot). Requires oil with API Classification CJ-4 or CK-4. See Note.
		•			TK486V25L and TK488CR Engines Only: Adjust engine valve clearance.
			•		TK486V25L1 and TK488CR1 Engines Only: Adjust engine valve clearance.
		•			TK486V25L and TK486V25L1 Engines only: Test fuel injection nozzles at least every 3,000 hours. Based on EPA 40 CFR Part 89.

Maintenance Inspection Schedule

Pretrip	Every 1,500 Hours	Every 3,000 Hours*	Annual/ 4,500 Hours	As Needed	
Inspect/Check/Service These Items					
		•			<p>TK488CR and TK488CRH Engines Only: Inspect and clean the EGR system as necessary according to the maintenance schedule. When alarm code 618 is active, the engine operation will be in default running mode and be limited to low-speed and 75% maximum-available-torque only. If an EGR valve alarm code (618/P148A) occurs on an engine with less than 5,000 total engine hours, clean the EGR valve and cooler as necessary to eliminate the alarm code.</p>
				•	<p>TK488CR1 and TK488CRH1 Engines Only: Inspect and clean the EGR system as necessary. No scheduled EGR system maintenance is required. Alarm Code 570 will display when the EGR system needs cleaning. If cleaning is not completed when Code 570 is active, eventually, the EGR Valve deposit accumulation limit will be reached, and an EGR Valve Alarm Code 618 (P148A) will be set, and the engine operation will be limited to default running mode, low-speed and 75% maximum-available torque, only. Alarm Code 618 means that the accumulated deposit amount has exceeded the allowable limit. If Code 618 occurs on an engine with less than 5,000 total engine hours, clean the EGR Valve and Cooler as necessary to eliminate the Alarm Code.</p>
			—		<p>TK486V25L and TK486V25L1 Engines only: Replace fuel return lines between fuel injection nozzles every 10,000 hours.</p>
			—		<p>Change ELC (red) engine coolant every 5 years or 12,000 hours.</p>
			—		<p>Note: <i>Units equipped with Severe Duty Filtration Package - Replace air cleaner element, replace fuel filter/water separator, and change engine oil and oil filter every 4,000 hours.</i></p>
					Electrical:
	•	•	•		Inspect battery terminals and electrolyte level.

Maintenance Inspection Schedule

Pretrip	Every 1,500 Hours	Every 3,000 Hours*	Annual/ 4,500 Hours	As Needed	
					Inspect/Check/Service These Items
	•	•	•		Inspect wire harness for damaged wires or connections.
			•		Inspect AC generator and alternator wire connections for tightness.
			•		Inspect electric motors.
			•		Inspect and, if required, re-torque all electrical connections on the contactors in the Fan Control Box to 15 in-lb (1.7 N•m).
			•		Inspect and, if required, re-torque all electrical connections on the contactors in the High Voltage Box in SmartPower units. Torque the connections on the Compressor Motor Contactor, Phase Contactors, and Overload Relay to 22 in-lb (2.5 N•m). Torque the connections on all other contactors to 15 in-lb (1.7 N•m).
					Refrigeration:
•	•	•	•		Check refrigerant level.
	•	•	•		Check for proper suction pressure.
	•	•	•		Check compressor oil level and condition.
			•		Check compressor efficiency and pump down refrigeration system.
			•		Empty oil collection container mounted on compressor.
			—		Replace dehydrator and check discharge and suction pressure every two (2) years.
					Structural:
•	•	•	•		Visually inspect unit for fluid leaks.
•	•	•	•		Visually inspect unit for damaged, loose, or broken parts (includes air ducts and bulkheads).

Maintenance Inspection Schedule

Pretrip	Every 1,500 Hours	Every 3,000 Hours*	Annual/ 4,500 Hours	As Needed	
					Inspect/Check/Service These Items
	•	•	•		Visually inspect the top of the unit for debris, soot build up, branches, and bird nesting material – remove debris.
	•	•	•		Inspect idlers for bearing wear (noise).
	•	•	•		Clean entire unit including condenser and evaporator coils and defrost drains.
	•	•	•		Check all unit and fuel tank mounting bolts, brackets, lines, hoses, etc.
* 3,000 hours or two years, whichever occurs first. ** Based on EPA 40 CFR Part 89.					

Remote Evaporator(s)

Pretrip	Every 1,500 Hours	Every 3,000 Hours*	Annual/ 4,500 Hours		
					Inspect/Check/Service These Items
					Electrical:
	•	•	•		Inspect wire harness for damaged wires or connections.

Maintenance Inspection Schedule

Pretrip	Every 1,500 Hours	Every 3,000 Hours*	Annual/ 4,500 Hours	<p style="text-align: center;">Inspect/Check/Service These Items</p>
	•	•	•	
				Structural:
•	•	•	•	Visually inspect unit for fluid leaks.
•	•	•	•	Visually inspect unit for damaged, loose, or broken parts.
	•	•	•	Clean entire unit including evaporator coils and defrost drains.
			•	Check all unit mounting bolts, brackets, lines, hoses, etc.

Serial Number Locations

Figure 144. Unit Serial Number Locations



1.	On Evaporator Housing
2.	On Frame In Engine Compartment

Figure 145. Laminated Serial Number Plate (Located Where Shown Above)



1.	Unit Serial Number
2.	Unit Model
3.	Bill of Material Number

**Figure 146. Serial Number Plate Location
(S-3 shown, S-2 similar)**



- | | |
|----|--|
| 1. | Serial nameplate on right end of evaporator frame behind cover |
|----|--|

Emergency Cold Line

If you can't get your unit operating and need assistance, you can locate a Thermo King Dealer anywhere in the United States by going to thermoking.com or by using the Thermo King North American Service Directory (available from any Thermo King dealer). If you are unable to reach a dealer, then call the Toll Free Emergency Cold Line Number (888) 887-2202. The answering service will assist you in reaching a dealer to get the help you need. The Cold Line is answered 24 hours a day by personnel who will do their best to get you quick service at an authorized Thermo King Dealer



Warranty

Please contact your nearest Thermo King dealer for terms of the Thermo King North American Trailer Unit Limited Warranty.

EPA and ARB Supplemental Emissions Warranty Statement

Your Thermo King unit is covered by the diesel engine manufacturer's EPA and ARB Supplemental Emissions Warranty. Complete details of this emission warranty can be found at www.thermo.com/manuals reference TK 56690-9-WA.

CALIFORNIA Proposition 65 Warning



RCS1032

Thermo King – by Trane Technologies (NYSE: TT), a global climate innovator – is a worldwide leader in sustainable transport temperature control solutions. Thermo King has been providing transport temperature control solutions for a variety of applications, including trailers, truck bodies, buses, air, shipboard containers and railway cars since 1938. For more information, visit www.thermoking.com or www.tranetechnologies.com.

Thermo King has a policy of continuous product and product data improvements and reserves the right to change design and specifications without notice. We are committed to using environmentally conscious print practices.