



Operator's Manual

Truck Edition

V-520 10/20/30/50, V-520 MAX

February 2012

TK-54342-18-OP

Revision 1

TRANE
TECHNOLOGIES

**V-520 10/20/30/50,
V-520 MAX
10/20/30/50**

TK 54342-1-OP (Rev. 1, 02/12)

**Copyright© 2009 Thermo King Corp., Minneapolis, MN, USA
Printed in USA**

Introduction

There is nothing complicated about operating and maintaining your Thermo King unit, but a few minutes studying this manual will be time well spent.

Performing pre-trip checks and enroute inspections on a regular basis will minimize on-the-road operating problems. A regular maintenance program will also help to keep your unit in top operating condition. If factory recommended procedures are followed, you will find that you have purchased the most efficient and dependable temperature control system available.

All service requirements, major and minor, should be handled by a Thermo King dealer for four very important reasons:

- They are equipped with the factory recommended tools to perform all service functions
- They have factory trained and certified technicians
- They have genuine Thermo King replacement parts
- The warranty on your new unit is valid only when the repair and replacement of component parts is performed by an authorized Thermo King dealer.

IMPORTANT: This manual is published for informational purposes only and the information furnished herein should not be considered as all-inclusive or meant to cover all contingencies. If more information is required, consult your Thermo King Service Directory for the location and telephone number of the local dealer.

Introduction

Table of Contents

Introduction	3	box.	18
Safety Precautions	9	Control Circuits	18
Automatic Start/Stop Operation	9	Electronic Control System	18
Electrical Hazard	10	Electronic Control System Description	19
Refrigerant	10	Unit Controls	21
Refrigerant Oil	10	In-cab Control Box	21
First Aid	11	Refrigerant	22
First Aid–Refrigerant	11	Liquid Injection System	22
First Aid–Refrigerant Oil	11	Evaporator Drain Tube Heaters	23
Safety Decals and Locations	12	Electric Standby Operation	23
Model 20/50 Units (Electric Standby)	13	Oil Separator	23
Unit Description	15	Protection Features	24
Introduction	15	Unit Operation	29
Standard Features	16	Starting the Unit	30
Optional Features	16	Engine Operation	30
Refrigeration System	17	Electric Standby Operation	30
Evaporator	18	Standard Display	31
The evaporator is mounted on the ceiling inside the truck		Single-temperature Units	31
		Multi-temperature Units	32

Table of Contents

Entering the Setpoint Temperature	32	Maintenance Inspection Schedule	49
In Single-temperature Units:	32	Electrical	50
In Multi-temperature Units	33	Refrigeration	50
Initiating the Manual Defrost Cycle	34	Structural	50
Alarms	35	Loading and Enroute Inspections	53
Manual Start:	35	Pre-Loading Inspection	53
Auto Start:	35	Inspecting the Load	55
Buzzers	36	Enroute Inspections	56
Alarm Code Descriptions	37	Serial Number Locations	59
Clearing Alarm Codes	38	Warranty	61
Viewing Information Screens	38	Glossary	63
Main Menu	38	Emergency Cold Line	69
Hourmeter Menu	38	Recover Refrigerant	70
Post-Start Inspection	39	CALIFORNIA Proposition 65 Warning	71
Loading Procedure	39		
Procedure after loading	39		
Specifications	41		
Electrical System	41		
Refrigerant System	43		
Compressors	44		
AC Semi-Hermetic Compressor	46		
Solder Applications	47		

Safety Precautions

Thermo King recommends that all services be performed by a Thermo King dealer. However, there are several general safety practices which you should be aware of:



WARNING: *Always wear goggles or safety glasses when working with or around the refrigeration system or battery. Refrigerant or battery acid can cause permanent damage if it comes in contact with your eyes.*



WARNING: *Keep hands and loose clothing clear of fans and belts at all times when the unit is operating or when opening or closing compressor service valves.*



WARNING: *Exposed coil fins can cause painful lacerations. Service work on the evaporator or condenser coils is best left to a certified Thermo King technician.*



CAUTION: *Use extreme caution when drilling holes in the unit. Drilling into electrical wiring or refrigerant lines could cause a fire. Never drill into structural components.*

Automatic Start/Stop Operation

This unit is capable of automatic operation and may start at any time without prior warning.



WARNING: *The unit may start at any time when the controller is turned on. The controller display lights up when the controller is turned on.*



WARNING: *Units equipped with electric standby may start at any time when the unit is connected to live electric power and the controller is turned on.*

Safety Precautions



WARNING: *Be sure to press the OFF key to turn the controller off before opening doors or inspecting any part of the unit.*



DANGER: *Fluorocarbon refrigerants tend to displace air and can cause oxygen depletion which could result in DEATH BY SUFFOCATION. Provide adequate ventilation in enclosed or confined areas.*

Electrical Hazard



CAUTION: *Be sure to turn off the high voltage power supply, and disconnect the electric cable before working on the unit. Units with electric standby present a potential electrical hazard.*



WARNING: *Fluorocarbon refrigerants evaporate rapidly, freezing anything they contact if accidentally released into the atmosphere from the liquid state.*

Refrigerant

Although fluorocarbon refrigerants are classified as safe, observe caution when working with refrigerants or around areas where they are being used in the servicing of your unit.



DANGER: *Fluorocarbon refrigerants may produce toxic gases. In the presence of an open flame or electrical short, these gases are severe respiratory irritants CAPABLE OF CAUSING DEATH.*

Refrigerant Oil

Observe the following precautions when working with or around refrigerant oil:



WARNING: *Always wear goggles or safety glasses to protect eyes from refrigerant oil contact.*



WARNING: *Protect skin and clothing from prolonged or repeated contact with refrigerant oil. Rubber gloves are recommended.*

Safety Precautions



WARNING: Wash thoroughly immediately after handling refrigerant oil to prevent irritation.

First Aid

First Aid–Refrigerant

Eyes: For contact with liquid, immediately flush eyes with large amounts of water. Get prompt medical attention.

Skin: Flush areas with large amounts of warm water. Do not apply heat. Wrap burns with dry, sterile, bulky dressing to protect from infection or injury. Get prompt medical attention.

Inhalation: Move victim to fresh air and restore breathing if necessary. Stay with victim until arrival of emergency medical personnel.

First Aid–Refrigerant Oil

Eyes: Immediately flush eyes with large amounts of water for at least 15 minutes while holding the eyelids open. Get prompt medical attention.

Skin: Remove contaminated clothing. Wash thoroughly with soap and water. Get medical attention if irritation persists.

Inhalation: Move victim to fresh air and restore breathing if necessary. Stay with victim until arrival of emergency personnel.

Ingestion: Do not induce vomiting. Immediately contact local poison control center or physician.

Safety Decals and Locations

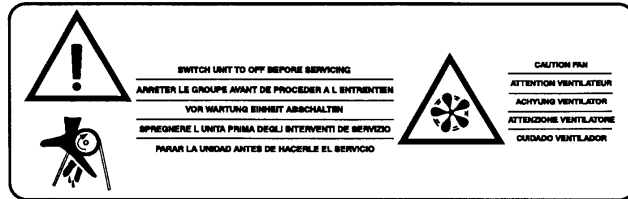

AKA98

Figure 1: Belt Caution (Locations vary depending on model. Decals are located near areas that contain belts and fans which can cause severe injuries if hands or clothing become tangled.)



AKA99

Figure 2: Automatic Start Caution (Locations vary depending on model. Decals are located near areas that contain moving parts which can cause severe injuries if hands or clothing become tangled when the unit automatically starts.)

Safety Precautions

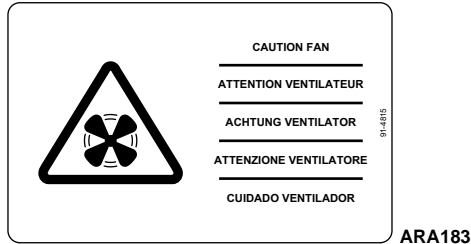

Figure 3: Fan Caution (Locations vary depending on model. Decals are located near areas that contain fans which can cause severe injuries if hands or clothing become tangled.)

Model 20/50 Units (Electric Standby)

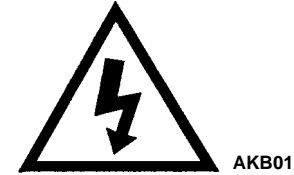

Figure 4: Electrical Hazard (Locations vary depending on model. Typically located near power receptacle, high voltage tray cover and interface board.)

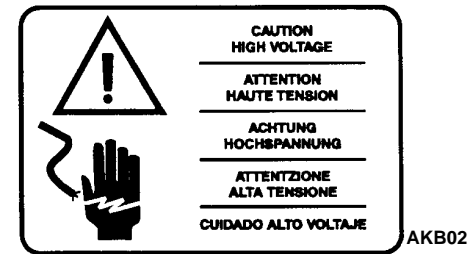

Figure 5: High Voltage Caution (Located near high voltage box.)

Safety Precautions

Unit Description

Introduction

The Thermo King V-520 10/20 and V-520 MAX truck refrigeration systems are two piece units. The unit is designed for medium-sized trucks and vans carrying fresh produce and frozen and deep frozen goods.

The condenser is mounted on the front of the truck box or container. The evaporator is mounted on the cargo compartment ceiling. The main compressor is powered by the vehicle engine via a belt. The unit is connected to the compressor by refrigeration hoses. In electric standby operation models, the second compressor is driven by an electric motor.

Control circuits operate on 12 and 24 VDC supplied by the truck batteries for over-the-road operation. The refrigeration system is protected by a high pressure cutout and a low pressure cutout.

The operating mode is selected automatically: When the unit is connected to an electric power source, engine-driven operation is automatically blocked. If the vehicle engine is started up while the power cable is still connected to the electric power source, the unit will continue to operate in electric standby mode. It is not possible to start the engine-driven compressor until the power cable is disconnected from the unit.

There are two basic models:

- Model 10: Cool and defrost on truck engine driven compressor operation.
- Model 20: Cool and defrost on both truck engine driven compressor operation and electric standby compressor operation.
- Model 30: Cool, heat and defrost on truck engine driven compressor operation.
- Model 50: Cool, heat and defrost on both truck engine driven compressor operation and electric standby compressor operation.

Unit Description

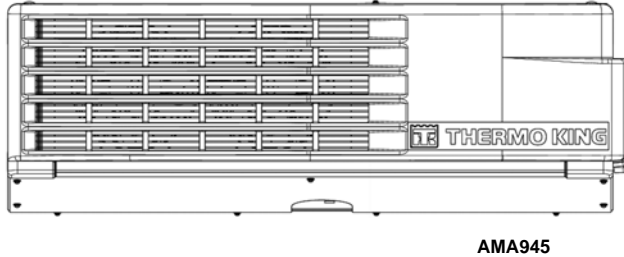

Figure 6: V-520 Condenser Unit

Standard Features

- In-Cab Controls with Digital LCD Thermometer
- Hot Gas Defrost
- Defrost Termination Switch
- Oil Separator
- Liquid Injection
- Main Compressor, 6-Cylinder Swash Plate

Optional Features

- Electric Compressor, Model 20 and 50 Units
- Evaporator Drain Heaters (MAX Units Only)
- Electric/Hot Water Heat (Model 20 before fourth quarter of 2011 and Model 20 SPECTRUM only)
- Hot Water Heat (Model 10 before fourth quarter of 2011 and Model 10 SPECTRUM only)
- Hot Gas Heat (Model 30 and 50 Units Only)

Unit Description

Refrigeration System

Refrigeration hoses or lines are used to connect the condenser, the evaporator, the compressor and any other components. Model 20 units have another compressor and an electric motor mounted in the condenser section for electric standby operation.

The engine compressor is driven by a belt from the engine. The electric standby compressor is connected in parallel with the engine-driven compressor. The standby compressor is hermetically sealed with its electric motor. Both compressors use the same refrigeration system circuit. Check valves isolate one compressor from the other during operation.

Compressor operation is controlled by the thermostat, which energizes the compressor clutch during engine operation or starts the electric motor and energizes the compressor clutch on electric standby operation. The refrigeration system is protected by a high pressure cutout switch and a low pressure cutout switch.

When plugged into standby power, engine operation is automatically locked out. If the truck engine is turned on while the power cord is still plugged into a power receptacle, the unit will remain working in electric mode; the engine driven compressor cannot be started until the power cord is unplugged from the unit as the selection of engine operation or standby operation is automatic.

Unit Description



Figure 7: Evaporator

Evaporator

The evaporator is mounted on the ceiling inside the truck box.

Control Circuits

The control circuits operate on 12 and 24 VDC supplied by the truck batteries for engine operation. On standby operation, the power is rectified from an AC transformer.

Electronic Control System

Thermo King direct drive refrigeration units are composed of a condenser unit, an evaporator unit (two evaporators in multi-temperature units), a vehicle compressor (in models with electric standby there is a second compressor that is driven by an electric motor) and a control panel (In-cab Control Box) that operates the unit.



ASA246

ASA246

Figure 8: In-Cab Control Box

Unit Description

The Electronic Control System is composed of an Electronic Control Module (located inside the condenser unit) and the In-cab Control Box. This In-cab Control Box allows the truck driver to operate the Thermo King refrigeration unit.

Electronic Control System Description

The Electronic Control System has the following characteristics:

- Auto Start
- Soft Start
- Active Display
- Lit Keypad
- Total Hourmeter
- Vehicle Compressor Hourmeter
- Electric Standby Compressor Hourmeter
- Low Battery Voltage Alarm
- Buzzer

- Unit Control without In-cab Control Box
- Manual or Automatic Defrost
- Maintenance Warning
- Return Air Temperature Sensor
- Setpoint Temperature Reading
- Electric Power Warning

Auto Start: Should the unit stop due to a failure in the power supply, whether during on-the-road or electric standby operation, it will start up again as soon as the power supply is re-established.

Soft Start: All operation modes remain inactive for 15 seconds after an Auto Start.

Active Display: The In-cab Control Box display is always active and backlit except when the unit is disconnected (no power) or when the unit is connected but has been manually switched off from the In-cab Control Box (when there is no active alarm).

Lit Keypad: The In-cab Control Box keys are always lit except when the unit is disconnected (no power) or when the unit is connected but has been manually switched off from the

Unit Description

In-cab Control Box (when there is no active alarm). The On/Off key is always lit except when the unit is disconnected (no power), and thus indicates the presence of power in the unit.

Total Hourmeter: Total number of hours the unit is in operation.

Vehicle Compressor Hourmeter: Number of hours the unit has been operating on-the-road.

Electric Standby Compressor Hourmeter: Number of hours the unit has been operating in electric standby.

Low Battery Voltage Alarm: Disconnects the unit when the battery voltage falls below 10.5V in 12VDC systems or below 21V in 24VDC systems.

Buzzer: It is energised when the vehicle battery and the electric power supply are connected at the same time. It is also energised if the doors are opened while the refrigeration unit is running.

Unit Control without In-cab Control Box: The unit can also be operated by the Electronic Control System without the In-cab Control Box, under conditions selected by the In-cab Control Box before it is disconnected.

Manual or Automatic defrost: It is possible to choose between manual or automatic defrost.

Maintenance Warning: On-screen warning of the need to carry out maintenance on the unit.

Return Air Temperature Sensor: On-screen reading of the temperature in the load compartment. In multi-temperature units, the temperature in both compartments can be read on the same screen.

Setpoint Temperature Reading: On-Screen Setpoint Temperature Reading. In multi-temperature units, the setpoint temperature of both compartments can be read on the same screen.

Electric Power Warning: On-screen warning that the unit is connected to an electric power supply.

Unit Description

Unit Controls

WARNING: *Never operate the unit unless you completely understand the controls; otherwise serious injury may occur.*

In-cab Control Box

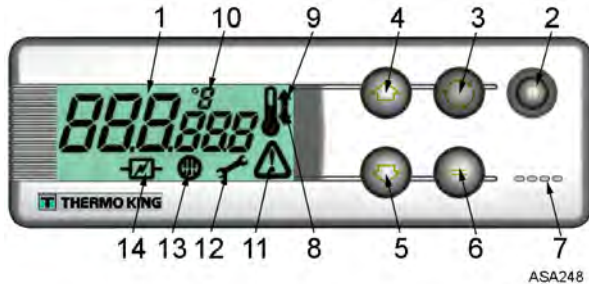

Figure 9: Display, Keys and Symbols

1. Display	It is always active and backlit except when the unit is disconnected (no power) or when the unit is connected but has been manually switched off from the In-cab Control Box. It normally displays the return air temperature (of both load compartments in multi-temperature units).
2. ON/OFF Key.	This key is used to start/stop the unit. It is always lit except when the unit is disconnected (no power), and thus acts as an indicator of the presence of power in the unit.
3. Select Key.	Selects prompt screens and information screens.
4. Up Key.	Is used to increase the setpoint temperature
5. Down Key.	Is used to reduce the setpoint temperature.

Unit Description

6. Enter Key.	Is used to enter a new command such as manual defrost, etc.
7. Buzzer.	It is energised when the vehicle battery and the electric power supply are connected simultaneously. It is also energised if the doors are opened while the refrigeration unit is running.
8. Cool Symbol	(Thermometer with an arrow pointing downward). The unit is cooling.
9. Heat Symbol	(Thermometer with an arrow pointing upward). The unit is heating.
10. C/ F Symbol.	Indicates whether the on-screen temperature reading is in degrees Celsius (C) or degrees Fahrenheit (F).
11. Alarm Symbol.	Indicates that there is an alarm in the system.
12. Maintenance Symbol.	Warns of the need to carry out maintenance to the unit.

13. Defrost Symbol.	Indicates the unit is in Defrost Mode.
14. Electrical Symbol.	Indicates that the unit is in Electric Standby.

Refrigerant

V-520-10, V-520-20, V-520-30 and V-520-50 units use R-134a refrigerant. V-520 MAX-10, V-520 MAX-20, V-520 MAX-30 and V-520 MAX-50 units use R-404A refrigerant.

Liquid Injection System

All V-520 models have a liquid injection system to limit discharge temperature of the engine driven compressor. If the discharge gas leaving the compressor reaches a temperature of 230 ± 5 F (110 ± 3 C) the liquid injection switch closes, providing voltage to the liquid injection solenoid. The solenoid opens a valve, allowing liquid refrigerant to flow from the liquid line near the drier inlet to the metering orifice attached to the suction line fitting on the engine driven compressor. As the

Unit Description

refrigerant passes through the metering orifice it expands and evaporates, cooling the suction gas entering the compressor. This cooling effect is transferred to the discharge gas leaving the compressor from the adjacent cavity in the compressor head. When the discharge gas is cooled to 200 ± 5 F (93 ± 3 C), the liquid injection switch opens, the liquid injection solenoid closes and refrigerant no longer flows through the liquid injection system.

Evaporator Drain Tube Heaters

Evaporator heaters are used in MAX units to avoid drain tube blockage because of ice accumulation inside the evaporator. One heater is located inside each drain tube. These resistive wire heaters melt the ice while the unit is in DEFROST mode.

Electric Standby Operation

During electric standby operation, the thermostat controls the operation of the unit by energizing and de-energizing the power relay and the electric relays. The thermostat places the unit in cool by energizing the motor contactor and the electric relays.

The thermostat places the unit in null by de-energizing all the relays and contactors. The thermostat places the unit in heat by energizing the heat contactor.

When the power relay and the electric relays are energized, they close contacts that energize the fan relay, the motor contactor, and the electric standby compressor clutch.

Oil Separator

An oil separator is a standard feature. The oil separator separates compressor oil from the refrigerant and returns the oil to the compressor through the suction line. The oil separator helps provide positive oil return at high compressor speeds and low operating temperatures. This feature enhances compressor lubrication and extends compressor life.

Unit Description

Protection Features

High Pressure Transducer: The high pressure transducer is a pressure sensitive device. It is located in the discharge line near the oil separator or the discharge check valve. If the discharge pressure rises above the transducer's opening pressure, the ECM opens the circuit to the compressor clutch to stop the unit.

Low Pressure Cutout Switch: The Low Pressure Cutout Switch is a pressure sensitive switch located in the suction line. If the pressure falls below acceptable limits, the switch opens the LPCO/CH circuit. This signals the ECM to open the circuit to the compressor clutch to stop unit operation.

Fuses

Fuse 1: Protects the Power Supply Circuit.

Fuse 2: Protects the Condenser Fan Motor (CFM1).

Fuse 3: Protects the Evaporator Fan Motor (EF1).

Fuse 4: Protects the Evaporator Fan Motor (EF2).

Fuse 5: Protects the Compressor Clutch 1 (CCL1), Liquid Injection Switch (LIS), Liquid Injection Valve (LIV), Host Hot Gas Defrost Solenoid Valve (PS1), Compressor Motor Contactor (CC), 26A Circuit to Heat Option

Fuse 6: Protects the Condenser Fan 1, 2 (CFM1 and CFM2).

Fuse 7: Protects the Condenser Fan Motor (CFM2).

Fuse 8: Protects the Remote Liquid Solenoid Valve (PS2), Host Liquid Solenoid Valve (PS3), Remote Hot Gas Defrost Solenoid Valve (PS4), and Suction Bypass Solenoid (PS6).

Fuse 9: Protects the Evaporator Fan Motor (EFM3)

Fuse 10: Protects the Evaporator Fan Motor (EFM4)

Fuse 11: Protects the Defrost Drain Heaters (DH1 and DH2)

Fuse 20: Transformer Input (L1)

Fuse 21: Battery Relay (Located in 2 wire near battery)

Unit Description

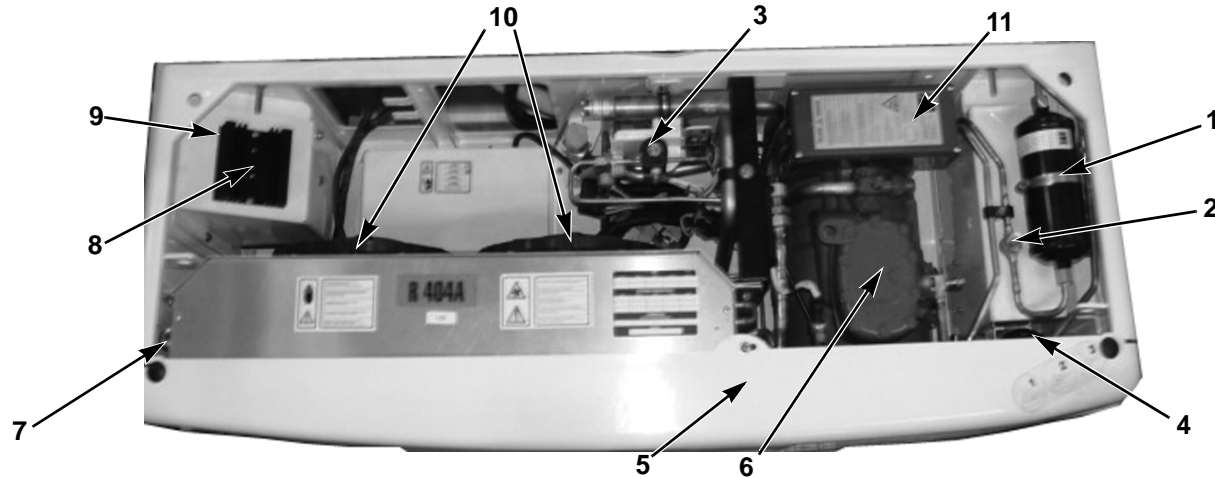

AMA1412

1.	Filter-Drier	5.	Oil Separator (under cover)	9.	Transformer Cover
2.	Liquid Sight Glass	6.	Electric Standby Compressor	10.	Condenser Fans
3.	Liquid Injection Valve	7.	Condenser Coil	11.	AC Compressor Electric Box
4.	Liquid Tank (?)	8.	Rectifier Heat Sink		

Figure 10: Unit Components (Model 20)

Unit Description

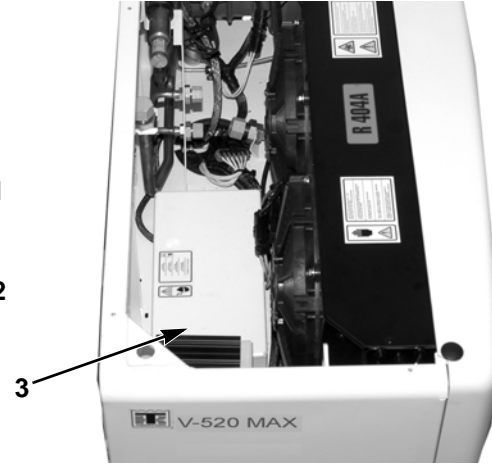
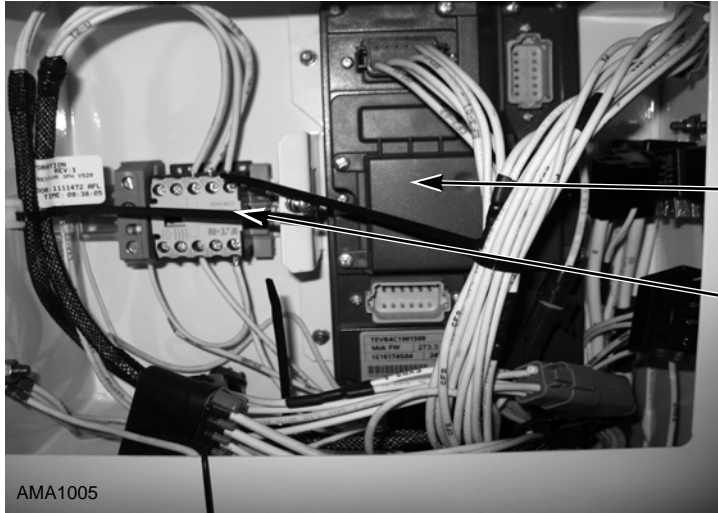

1.	Electronic Control Module (single temp shown)	3.	Capacitor Box
2.	Motor Contactor		

Figure 11: Condenser Electric and Capacitor Boxes (Model 20 and 50)

Unit Description

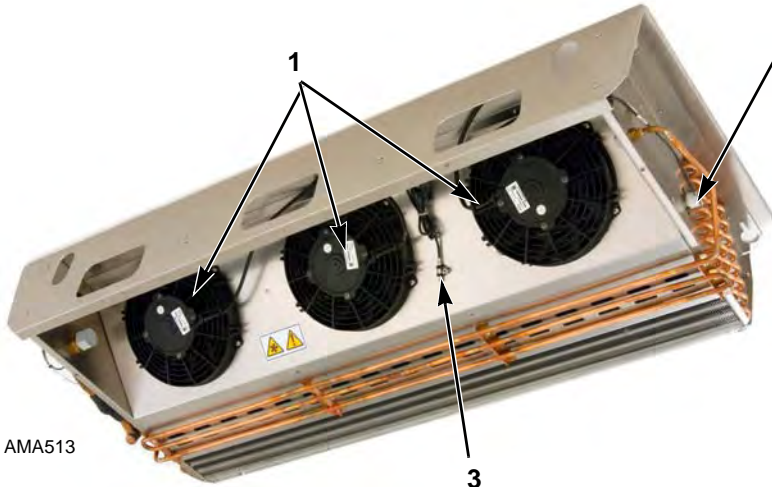

AMA513



AMA514

1.	Evaporator Fans	3.	Air Temperature Sensor
2.	Expansion Valve	4.	Defrost Switch

Figure 12: Standard Evaporator

Unit Description

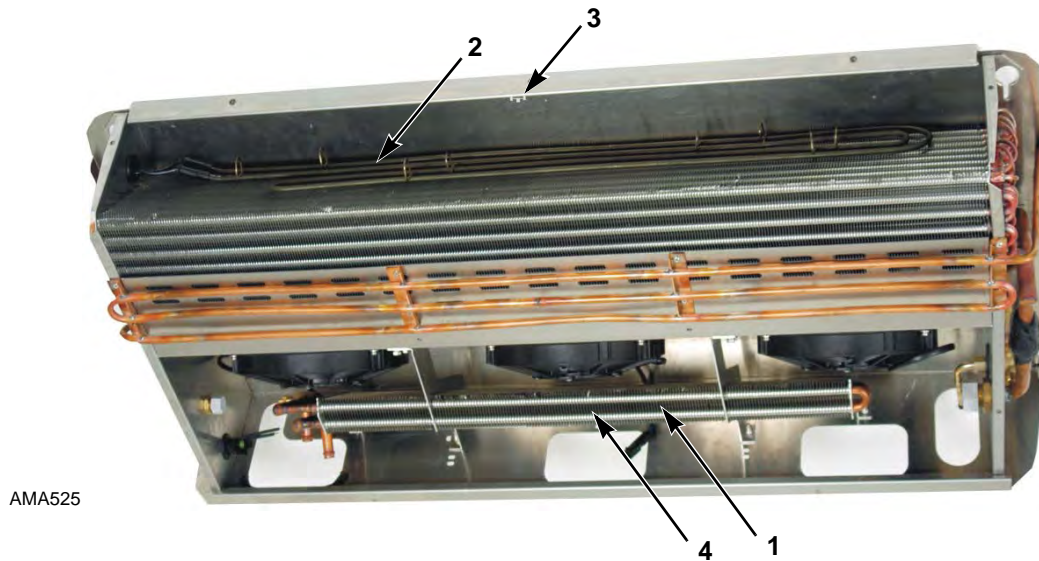

1.	Hot Water Heat Defrost Coil	3.	High Temperature Limit Switch
2.	Electric Heat Element	4.	Air Temperature Sensor

Figure 13: Evaporator with Hot Water and Electric Heat Options

Unit Operation

In truck-driven units, temperature control is based on two values: The setting (Setpoint) of the electronic thermostat and the evaporator return temperature. The difference between these two temperatures will determine the mode of operation: cool, heat, or null.

Cool: When the temperature in the load compartment is higher than the setpoint, the unit runs in cool mode to reduce the evaporator return temperature.

Heat: When the temperature in the load compartment is lower than the setpoint, the unit changes to heat mode to raise the evaporator return temperature.

Null: Once the Setpoint Temperature has been reached, and while the temperature remains between X F/C above or below the setpoint, there is no demand for transfer of heat or cold, and the unit runs in null mode.

Defrost: After a scheduled period of time in cool mode, between 1 and 8 hours, the unit runs in this fourth mode of operation to eliminate ice that has accumulated in the evaporator coil. Defrost can be initiated automatically or manually.

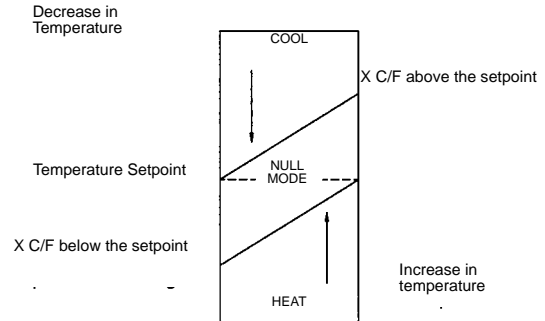

Unit Operation

Factory setting for X is 5 F (3 C). During unit installation, this value can be adjusted by between 2 and 9 F (1 and 5 C) in increments of 1 F/C.

Units with R-134a refrigerant: Temperatures can be controlled from -8 F to +71 F (-22 C to +22 C).

Units with R-404A refrigerant: Temperatures can be controlled from -26 F to +71 F (-32 C to +22 C).

Year of manufacture: Reference Serial Plate.

Installation and commissioning are to be carried out by an authorized Thermo King Dealer in accordance with Thermo King procedures and drawings. Exceptions to this with the written authorization of the manufacturer only.

Starting the Unit

Engine Operation

1. Start the truck engine.
2. Press the On/Off switch located in the In-cab Control Box. The In-cab Control Box display will be activated.
3. Check the setpoint, and adjust if necessary.

Electric Standby Operation

1. Connect the external power supply to the electric power receptacle. Ensure that the power supply is of the correct voltage and phase for the unit.
2. Press the On/Off switch located in the In-cab Control Box. The In-cab Control Box display will be activated. The electric symbol will appear on the screen.
3. Check the setpoint, and adjust if necessary.

Unit Operation

NOTE: The operating mode, whether engine-driven or electric standby, is selected automatically. When the unit is connected to an electric power source, engine-driven operation is automatically blocked. If the truck engine is started up while the power cable is still connected to the electric power source, the unit will continue to operate in electric standby mode.

Standard Display

This is the display that appears when the ON/OFF key is pressed and the unit started. It normally displays the return air temperature (of both load compartments in multi-temperature units) and the current operating mode with the appropriate symbol.

Should there be an alarm, the alarm symbol will also appear on screen

Single-temperature Units

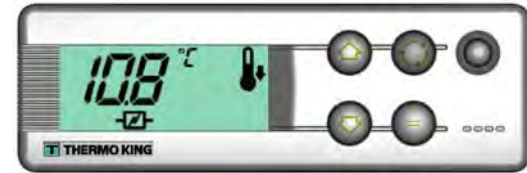

ASA249

Figure 14: Single-temperature Units

The example in the drawing shows: 10.8 C temperature, cool mode and standby operation.

Multi-temperature Units



Figure 15: Multi-temperature Unit

The example in the drawing shows: -10 C temperature and cool mode in the main compartment, and 2 C temperature and heat mode in the remote compartment. Unit running in on-the-road mode.

Entering the Setpoint Temperature

The Setpoint Temperature can be quickly and easily changed.

In Single-temperature Units:



Figure 16: Single-temperature Units

1. Press and release the SELECT key twice, and the current Setpoint Temperature and the letters SP will appear on screen.
2. Press the UP or DOWN arrow keys to select the desired Setpoint Temperature. Each time either of these buttons is pressed and released, the Setpoint Temperature will change 1 degree.
3. Press and release the SELECT key, and the Standard Display will reappear on screen.

IMPORTANT: If the SELECT key is not pressed within 20 seconds to select the new Setpoint Temperature, the unit will continue to run at the original Setpoint Temperature.

In Multi-temperature Units



ASA250

Figure 17: Multi-temperature Units

1. Main Load Compartment: Press and release the SELECT key twice, and the current Setpoint Temperature in the main compartment and the letters SP will appear on screen.
2. Press the UP or DOWN arrow keys to select the desired Setpoint Temperature. Each time either of these buttons is pressed and released, the Setpoint Temperature will change 1 degree.
3. Press and release the SELECT key to change to the Remote Compartment Setpoint Temperature Setting Screen.

IMPORTANT: If the SELECT key is not pressed within 20 seconds to select the new Setpoint Temperature, the unit will continue to run at the original Setpoint Temperature.

4. **Remote Load Compartment:** The present Setpoint Temperature in the remote compartment and the letters SP2 will appear on screen.



ASA251

5. Press the UP or DOWN arrow keys to select the desired Setpoint Temperature. Each time either of these buttons is pressed and released, the Setpoint Temperature will change 1 degree.
6. Press and release the SELECT key, and the Standard Display will reappear on screen.

IMPORTANT: If the SELECT key is not pressed within 20 seconds to select the new Setpoint Temperature, the unit will continue to run at the original Setpoint Temperature.

Initiating the Manual Defrost Cycle

CAUTION: Before initiating a manual defrost, ensure that the unit is not already in a defrost cycle. When the unit is in a defrost cycle the defrost symbol appears on screen.

1. Press and release the SELECT key once, and the letters dEF will appear (flashing) on screen along with the present defrost condition OFF.



Figure 18: Defrost Condition Off

2. To activate manual defrost, press the ENTER key and then the UP or DOWN key and the defrost condition will change to ON.



Figure 19: Defrost Condition On

3. Press the SELECT key twice to return to the STANDARD DISPLAY (three times in multi-temperature units), where the DEFROST symbol will appear when the defrost cycle begins (the klixon must be closed).

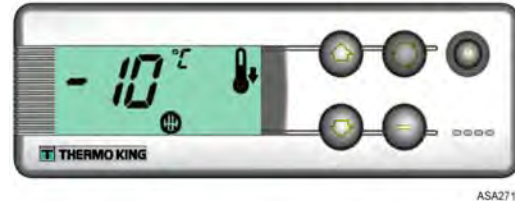

Figure 20: Defrost Symbol in Display

Unit Operation

Alarms

When the unit is not operating properly, the microprocessor records the alarm code, alerts the operator by displaying the ALARM symbol and, depending on the type of alarm, shuts the unit down.

There are three alarm categories:

Manual Start:

The alarm stops the unit, and only the ALARM symbol appears on screen.

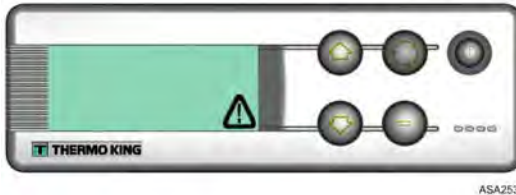

Figure 21: Manual Start

Once the alarm condition has been rectified, the ON/OFF key must be pressed to start up again.

Press and release the SELECT key to display the current alarm code on screen. If there is more than one active alarm, all the alarm codes on the unit can be viewed in sequence by pressing and releasing the SELECT key.

Auto Start:

The alarm stops the unit, the ALARM symbol appears on screen and the unit starts up automatically once the alarm condition has been rectified.

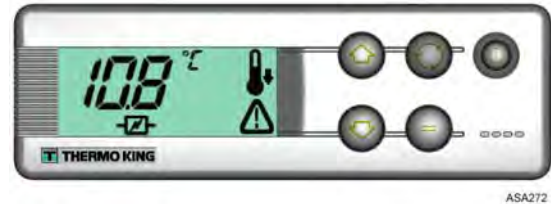

Figure 22: Auto Start

Unit Operation

Should a **P1E** alarm occur - return air temperature read error alarm code - appear, --- will appear on screen together with the alarm symbol, instead of the return air temperature reading.

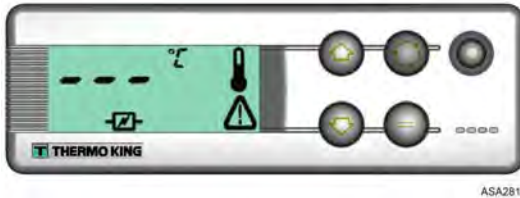

Figure 23: P1E Alarm

In multi-temperature units, should a P2E - return air temperature read error in the remote compartment alarm code - appear, --- will also appear on screen together with the alarm symbol, instead of the remote compartment return air temperature reading.

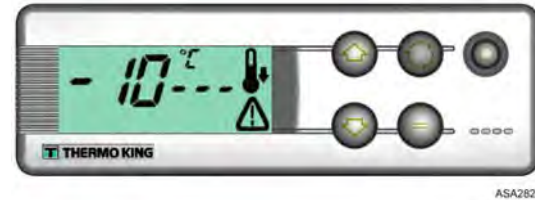

Figure 24: P2E Alarm

Press and release the SELECT key to display the current alarm code on screen. If there is more than one active alarm, all the alarm codes on the unit can be viewed in sequence by pressing and releasing the SELECT key.

Buzzers

They are energized when the vehicle battery and the electrical supply are connected simultaneously (the unit continues running in standby mode). They are also energized if the doors open, if this option is selected.

Alarm Code Descriptions

Alarm	Description
Manual Start	
OL	Electric Motor Overload. Unit protection system during electric standby operation. <i>If the problem persists when the unit is restarted, contact your Service Dealer.</i>
bAt	Low Battery Voltage. Unit and battery protection system.
Auto Start	
HP	High Pressure Alarm. Indicates that the refrigeration system will shut down in the event of excessively high pressure in the refrigerant circuit. <i>If the problem persists when the unit is restarted, contact your Service Dealer.</i>

Alarm	Description
LP	Low Pressure Alarm. Indicates that the refrigeration system will shut down in the event of excessively low pressure in the refrigerant circuit. <i>If the problem persists when the unit is restarted, contact your Service Dealer.</i>
PSE	High Pressure Sensor Failure. The high pressure sensor has become faulty or disconnected. <i>Contact your Service Dealer.</i>
tEP	Thermal protection alarm. <i>If the problem persists when the unit is restarted, contact your Service Dealer</i>
dr1, dr2	Doors Open. <i>This option must be activated.</i>
tCO (Hot)	Control Module Overheating. <i>If the problem persists when the unit is restarted, contact your Service Dealer.</i>
SOF	Software failure. <i>Contact your Service Dealer.</i>

Unit Operation

Alarm	Description
P1E	Main or Single Cargo Box Return Air Temperature Reading Error (open circuit or short-circuit). <i>Contact your Service Dealer.</i>
P2E	Remote Cargo Box Return Air Temperature Reading Error (open circuit or short-circuit). <i>Contact your Service Dealer.</i>
C	Communications Failure. <i>Contact your Service Dealer.</i>

Clearing Alarm Codes

The alarm condition in the unit must first be corrected. After clearing the alarm condition, press and release the **SELECT** key to remove existing **ALARM** codes. The standard display will appear once the **ALARM** codes have been cleared.

Viewing Information Screens

Main Menu

From the **Standard Display** use the **SELECT** key to display:

1. Alarms (if any active)
2. Manual Defrost
3. Temperature Setpoint

Hourmeter Menu

From the Standard Display press the **SELECT** key for 3 seconds to open the **Hourmeter** Menu, then use the **SELECT** key to display:

1. **HC**: Hours remaining to maintenance notice.
2. **tH**: The total amount of time the unit has been switched on protecting the load.
3. **CC**: Engine-driven compressor operating hours.
4. **EC**: Electric standby compressor operating hours.
5. Return to Main Menu.

Post-Start Inspection

Thermostat: Adjust the thermostat setting to above and below the compartment temperature to check thermostat operation (see Operating Modes).

Pre-cooling: With the thermostat set at the desired temperature, run the unit for half-an-hour to one hour (or longer if possible) before loading the truck. Pre-cooling eliminates residual heat and acts as a good test of the refrigeration system.

Defrost: When the unit has finished pre-cooling the truck interior - the evaporator temperature should have dropped below 2 C (35.6 F) - initiate a defrost cycle with the manual defrost switch. The defrost cycle should stop automatically.

Loading Procedure

1. To minimize frost accumulation in the evaporator coil and a heat increase inside the load compartment, ensure that the unit is OFF before opening the doors. (The unit may continue to run when the truck is being loaded in a warehouse with the doors closed.)

2. Carefully check and record the load temperature when loading the truck. Note whether any products are out of temperature range.
3. Load the product in such a way that there is sufficient space for the air to circulate throughout the load. DO NOT block the evaporator inlet or outlet.
4. Product should be pre-cooled before loading. Thermo King units are designed to maintain the load at the temperature at which it is loaded. Transport refrigeration units are not designed to reduce the load temperature.

Procedure after loading

1. Ensure that all doors are closed and locked.
2. Adjust the thermostat to the desired temperature setpoint.
3. Start the unit.
4. Half an hour after loading the truck, defrost the unit for a moment by pressing the Manual Defrost switch. If the coil temperature drops to below 2 C (35.6 F), the unit will defrost. The defrost cycle should stop automatically.

Unit Operation

Specifications

Electrical System

Fuses	12 Volt	24 Volt
Fuse 1: Power Supply Circuit	5 amps	5 amps
Fuse 2: Condenser Fan Motor (CFM1)	15 amps	10 amps
Fuse 3: Evaporator Fan Motor (EF1)	15 amps	10 amps
Fuse 4: Evaporator Fan Motor (EF2)	15 amps	10 amps
Fuse 5: Compressor Clutch 1 (CCL1), Liquid Injection Switch (LIS), Liquid Injection Valve(LIV), Host Defrost Hot Solenoid Valve (PS1), Compressor Motor Contactor (CMC), Heat Pilot Solenoid (PS5), Compressor Clutch 2 (CCL2)	20 amps	10 amps
Fuse 6: Condenser Fan 1, 2 (CF1, CF2) Heater 1, Heater 2 (HT1, HT2)	10 amps	7.5 amps
Fuse 7: Condenser Fan Motor (CFM2)	15 amps	10 amps
Fuse 8: Remote Liquid Solenoid Valve (PS2), Host Liquid Solenoid Valve (PS3), Remote Defrost Hot Gas Solenoid Valve (PS4)	20 amps	10 amps
Fuse 9: Evaporator Fan Motor (EF3)	15 amps	10 amps
Fuse 10: Evaporator Fan Motor (EF4)	15 amps	10 amps
Fuse 11: Heaters	10 amps	7.5 amps

Specifications

Electrical System

Fuses		12 Volt	24 Volt
Fuse 20: Transformer		4 amps	4 amps
Fuse 21: Battery Relay		15 amps	15 amps
Condenser Fan Motors			
Voltage	Full Load rpm	Full Load Current	
13 Vdc	3000	9.2 Amps	
Evaporator Fan Motors			
Voltage	Full Load rpm	Full Load Current	
13 Vdc	2700	6.2 Amps	
Coils for Hot Gas Solenoids, Condenser Solenoids, and Liquid Line Solenoids			
Voltage	Current	Resistance	
12 Vdc	2.3 amps	5.2 ohms	

Specifications

Refrigerant System

R-134A REFRIGERATION SYSTEM (V-520)		
Refrigerant Charge:	V-520 - Model 10	7.93 lb (3.60 kg) R-134a
	V-520 - Model 20	7.93 lb (3.60 kg) R-134a
	V-520 - Model 30	8.00 lb (3.63 kg) R-134a
	V-520 - Model 50	8.00 lb (3.63 kg) R-134a
Defrost Termination Switch:	Opens	48.0 ± 5.4 F (8.9 ± 3.0 C)
	Closes	36.0 ± 5.4 F (2.2 ± 3.0 C)
Liquid Injection Switch (LIS):	Opens	200 ± 5 F (93 ± 3 C)
	Closes	230 ± 5 F (110 ± 3 C)
Low Pressure Cutout:	Opens	5 to 11 in. Hg vacuum (-17 to -34 kPa)
	Closes	4 to 7 psig (28 to 48 kPa)
Compressor Pressure Regulator (CPR) Valve Setting - Model 30 and 50 Only		50.0 psig (345 kPa)
Suction Pressure Regulator (SPR) Valve Setting - Model 20 and 50 Only		39.0 psig (269 kPa)
R-404A REFRIGERATION SYSTEM (V-520 Max)		
Refrigerant Charge:	V-520 MAX - Model 10	8.15 lb (3.70 kg) R-404A
	V-520 MAX - Model 20	8.15 lb (3.70 kg) R-404A

Specifications

Refrigerant System

	V-520 MAX - Model 30	8.25 lb (3.74 kg) R-404A
	V-520 MAX - Model 50	8.25 lb (3.74 kg) R-404A
	V-520 SPECTRUM - Model 10	9.75 lb (4.42 kg) R-404A
	V-520 SPECTRUM - Model 20	9.75 lb (4.42 kg) R-404A
Defrost Termination Switch:	Opens	48.0 ± 5.4 F (8.9 ± 3.0 C)
	Closes	36.0 ± 5.4 F (2.2 ± 3.0 C)
Liquid Injection Switch (LIS):	Opens	200 ± 5 F (93 ± 3 C)
	Closes	230 ± 5 F (110 ± 3 C)
Low Pressure Cutout:	Opens	5 to 11 in. Hg vacuum(-17 to -34 kPa)
	Closes	4 to 7 psig (28 to 48 kPa)
Compressor Pressure Regulator (CPR) Valve Setting - Model 30 and 50 Only		50.0 psig (345 kPa)
Suction Pressure Regulator (SPR) Valve Setting - Model 20 and 50 Only		39.0 psig (269 kPa)

Compressors

Main Compressor	10 cu. in. (163 cc), Engine Driven, Swash Plate, 6 Cylinder
Electric Standby Compressor - Model 20 and 50 Only	D211Y, Reciprocating, 3 Cylinder,

Specifications

Compressors (Continued)

System Oil Capacity:	Model 10	12 oz (355 cc)
	Model 20	64 oz (1893 cc)
	Model 30	18 oz (532 cc)
	Model 50	70 oz (2070 cc)
	SPECTRUM Model 10	16 oz (473 cc)
	SPECTRUM Model 20	30 oz (887 cc)
Compressor Oil Type		Polyol Ester P/N 203-515
Defrost Method:		Hot gas
Defrost Timer:	Initiation Interval	Adjustable, 1 hour to 10 hours
	Termination Interval	Termination is not timed. Defrost is terminated by Klixon switch.
	CAUTION: Failure to use correct Thermo King recommended oil will invalidate your warranty.	

Specifications

Belt Tension (Using Tool P/N 204-427)

	Field Reset
Engine Driven Compressor Belt	Check vehicle manufacturer specifications

AC Semi-Hermetic Compressor

Voltage/Phase/Frequency	Horsepower	Kilowatts	RPM	Full Load (Amps)	Locked Rotor Amps
230V/3PH/60Hz	2	1.5	1740	14.1	86.9
230V/1PH/60Hz	2	1.5	1740	16.0	83.2
400V/3PH/60Hz	2	1.5	1740	8.1	29.9
400V/3PH/50Hz	2	1.5	1450	6.8	24.9

Electric Standby Power Requirements

Supply Circuit Breaker	20 amp
Extension Cord Size	25 ft - 10 gauge, up to 75 ft - 8 gauge

Electric Heaters

Voltage	Power Rating Watts	Current	Resistance
208/230	2000	14.7 Amps	16.2 ohms at 230 V

Specifications

Solder Applications

Refrigeration Component	
For general refrigeration tubing connections: copper to copper or copper to brass	Joint Clearances: 0.003 to 0.005 in. (0.076 to 0.127 mm) Use: Solder Type 15% Silver TK No. 203-364 Use: Flux Type TK No. 203-365
For refrigeration tubing connections of dissimilar metals: copper to stainless steel or brass to stainless steel	Joint Clearances: 0.003 to 0.005 in. (0.076 to 0.127 mm) Use: Solder Type 35% Silver TK No. 203-366 Use: Flux Type TK No. 203-365

Hot Water Component	
For hot water tubing connections: copper to copper or copper to brass	Joint Clearances: 0.003 to 0.005 in. (0.076 to 0.127 mm) Use: Solder Type 95% Tin and 5% antimony TK No. 204-167 Use: Flux Type TK No. 204-417
For hot water tubing connections of dissimilar metals: copper to stainless steel or brass to stainless steel	Joint Clearances: 0.003 to 0.005 in. (0.076 to 0.127 mm) Use: Solder Type 35% Silver TK No. 203-366 Use: Flux Type TK No. 203-365

NOTE: Some units may be equipped with an compressor pressure regulating valve (CPR). To reduce the chance of overheating the CPR valve, 95-5 solder or equivalent may be used.

Use 95-5 TK No. 204-167

Use Flux TK No. 204-417

Specifications

Maintenance Inspection Schedule

A closely followed maintenance program will help to keep your Thermo King unit in top operating condition. The following general schedule is provided to assist in monitoring that maintenance.

For more specific detail, see the maintenance manual for your unit and to the PreTrip Inspection chapter in this manual.

After first week of operation:

- Check belt tension.
- Tighten unit mounting bolts.
- Check refrigerant level.

Maintenance Inspection Schedule

Weekly	Monthly	Semi-Annual	Annual	Inspect/Service These Items
				ELECTRICAL
		<ul style="list-style-type: none"> • • • 	<ul style="list-style-type: none"> • • • • • 	<ul style="list-style-type: none"> Check defrost initiation and termination. Check thermostat cycle sequence. Check operation of protection shutdown circuits. Check thermostat and thermometer calibration in 0 C (32 F) ice-water bath. Inspect wire harness for damaged wires or connections.
				REFRIGERATION
		<ul style="list-style-type: none"> • 	<ul style="list-style-type: none"> • • 	<ul style="list-style-type: none"> Check refrigerant level. Replace dehydrator.
				STRUCTURAL
<ul style="list-style-type: none"> • • • 	<ul style="list-style-type: none"> • • • • • 	<ul style="list-style-type: none"> • • • • • 	<ul style="list-style-type: none"> • • • • • 	<ul style="list-style-type: none"> Visually inspect unit and refrigerant hoses for fluid leaks. Visually inspect unit for damaged, loose or broken parts. Clean defrost drains. Inspect belts for condition and proper tension Clean entire unit including evaporator coil and condenser coil.

Maintenance Inspection Schedule

Weekly	Monthly	Semi-Annual	Annual	Inspect/Service These Items
		•	•	Check all unit mounting bolts, brackets, lines, hoses, etc.

Maintenance Inspection Schedule

Loading and Enroute Inspections

Thermo King refrigeration units are designed to maintain the required temperature for the product being carried during its time in transit. Because of the unit's unique design, special care is required during loading to prevent cargo spoilage.

Pre-Loading Inspection

1. Inspect all door seals, including vent doors, for condition and a tight seal with no air leakage.
2. Inspect the cargo compartment inside and out for damaged or loose skin and insulation.
3. Inspect the inside of the cargo compartment for damaged walls, air ducts, floor channels or "T" flooring, clogged defrost drain tubes, and clogged or damaged floor channels which could block the air return, creating isolated areas in the load that are warmer than the desired temperature.
4. Pre-cool the cargo compartment. Adjust the setpoint to the desired cargo temperature and allow the unit to run a minimum of 30 to 60 minutes (longer if possible) before loading. Check to be certain the setpoint temperature is correct for the cargo.

Pre-cooling before loading will remove residual heat and moisture from the cargo compartment and prepare it to receive the refrigerated load. Pre-cooling also provides a good test of the refrigeration system.
5. Make sure products are pre-cooled to the proper temperature before loading. Any variance should be noted on the manifest.
6. Supervise product loading to make sure that there is sufficient air space around and through the load so air flow is not restricted.

Loading and Enroute Inspections

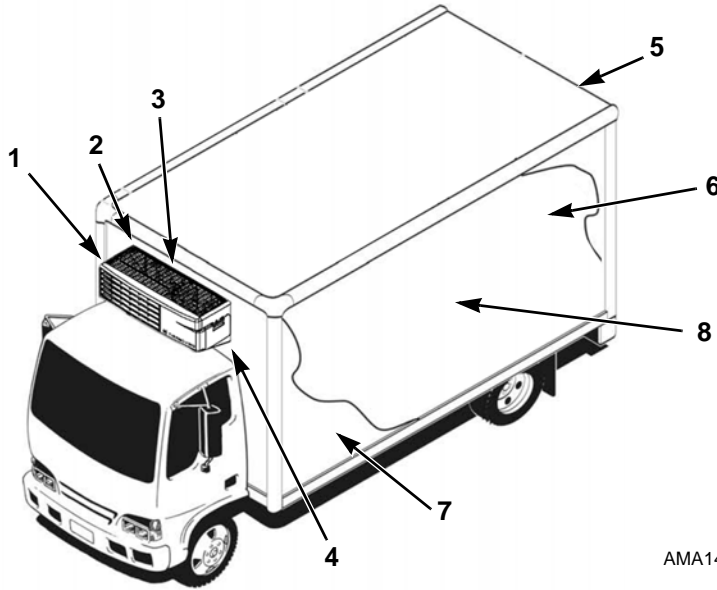

1.	Unit Inspection
2.	Good Outside Air Circulation
3.	Gaskets Equally Compressed
4.	Clear Defrost Drains
5.	Tight Doors
6.	Good Air Circulation Around Load
7.	Interior and Exterior Walls and Insulation in Good Condition
8.	Cargo at Proper Temperature Prior to Loading

AMA1411

Figure 25: Loading Considerations

Inspecting the Load

Never assume that the product has been loaded properly. Watch for and perform the following tasks. It takes only a few minutes and could save you or your employer considerable time and money later on.

1. Make sure the unit is off before opening the cargo compartment doors. During operation, the unit blows out refrigerated air, and draws in outside air.

NOTE: The unit can be run with the doors open if the truck is backed into a refrigerated warehouse with tight door seals.

2. Perform a final check of the load temperature. If the load is too hot or too cold, make a final notation on the manifest.



CAUTION: Make sure cargo is pre-cooled to the proper temperature before loading. The unit is designed to maintain temperature, not cool an above-temperature load.

3. While inspecting to see that the cargo is loaded properly, make sure the evaporator inlets and outlets are not blocked.
4. Close or supervise the closing of the cargo compartment doors. Make sure they are securely locked.
5. Check to make sure the unit setpoint is set at the desired temperature as listed on the manifest.
6. If the unit was stopped, restart using the appropriate starting procedure outlined in this manual.
7. Repeat the after-start inspection.
8. Defrost the unit 30 minutes after loading by starting a manual defrost cycle.

Enroute Inspections

NOTE: Enroute inspections are recommended every four hours for the prevention of damage to the cargo.

1. Note the setpoint to make certain no one has altered the setting since picking up the load.
2. Note the return air temperature reading. It should be within the desired temperature range. If the return air temperature reading is not within the desired temperature range, it indicates one of the following:
 - a. The unit has not had sufficient time to pull down the temperature. Refer to log, if possible, for history of load (for example, above temperature load, properly pre-cooled cargo compartment, length of time on road).
 - b. The unit is in defrost or has just completed defrost.

NOTE: You can cancel defrost by turning the unit off, then restarting the unit.

- c. The evaporator is plugged with frost. Initiate a manual defrost cycle. The defrost cycle will be automatically terminated.
- d. Improper air circulation within the cargo compartment. Inspect the cargo compartment (if possible) to determine if the evaporator fans are working and properly circulating the air. Poor air circulation can be due to improper loading of the cargo or shifting of the load.



WARNING: The unit may START automatically AT ANY TIME while it is turned ON. Make sure to turn the unit OFF before opening unit doors or inspecting any part of the unit.

Loading and Enroute Inspections

- e. The unit may have a low refrigerant charge. If liquid is not showing in the unit receiver tank sight glass, the refrigerant charge may be low. Adding refrigerant or repairing the refrigeration system requires a competent mechanic. Refer such problems to the nearest Thermo King dealer or authorized Service Center, or call the Thermo King Cold Line telephone number shown on the inside back cover of this manual for referral.

NOTE: If the temperature in the compartment is not within the desired temperature range, repeat the Enroute Inspection every 30 minutes until the compartment temperature comes within the desired temperature range.



CAUTION: Stop the unit if the compartment temperature remains outside the desired temperature range from the setpoint on two consecutive 30 minute inspections. Contact the nearest Thermo King Service Center or your company office immediately. Take all necessary steps to protect and maintain proper load temperature.

3. Initiate a Manual Defrost cycle after each Enroute Inspection.

Loading and Enroute Inspections

Serial Number Locations

CONDENSER: Nameplate located on the back inside wall of condenser frame.

ENGINE DRIVEN COMPRESSOR: Nameplate located on compressor body. The engine driven compressor is located in the truck engine compartment.

STANDBY COMPRESSOR: Nameplate located on compressor body. The Standby compressor is located inside the Condenser assembly.

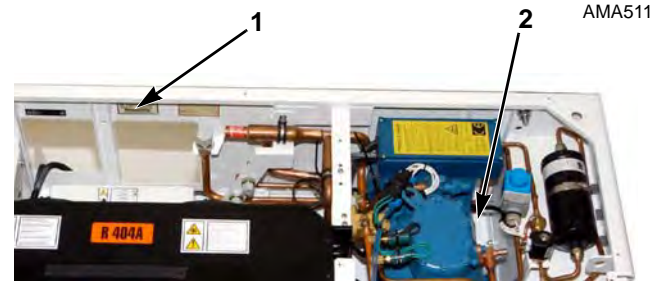

1.	Condenser Serial Number Location
2.	Stand By Compressor Serial Number Location

Figure 26: Condenser and Standby Compressor Serial Number Locations

Serial Number Locations

Warranty

Terms of the Thermo King Warranty are available on request.
Please reference document TK 51350 for the Thermo King
Self-Powered Truck Unit Warranty.

Warranty

Glossary

This glossary is published for informational purposes only and the information being furnished herein should not be considered as all-inclusive or meant to cover all contingencies.

NOTE: *Additional terms not found in the glossary may be located in the index section of this manual.*

accumulator: A device located in the suction line to collect liquid refrigerant and meter it safely back to the compressor as gas.

ambient air temperature: Temperature of the air surrounding an object.

amp: Abbreviation for ampere. The basic measuring unit of electrical current.

bar: A metric unit of pressure. 1 bar = 100 kPa = 14.5 psi.

Battery Sentry: Part of the CYCLE-SENTRY™ system. The Battery Sentry module monitors alternator charge rate and will keep the unit running until the battery is adequately charged.

box temperature: The temperature within a temperature-controlled compartment.

Btu (british thermal unit): The quantity of heat required to raise the temperature of one pound of water by one degree Fahrenheit. 1 Btu = 252 calories.

bulkhead: 1) *return air bulkhead.* A metal or plastic “wall” placed at the front of the box to prevent loading of product tightly against the Thermo King unit. (Loading too close to the unit restricts air flow and system efficiency.) 2) *bulkhead divider.* A thick, insulated “wall” used to separate compartments of a multi-temperature truck or trailer.

calorie: The amount of heat required to raise temperature of one gram of water one degree Celsius. 1 calorie = 0.004 Btu.

Celsius: The metric unit of temperature measurement. The preferred alternate to the term centigrade. Abbreviated “C.”

centigrade. See *Celsius*.

Glossary

CFC: Chlorofluorocarbon. A chlorine-based refrigerant consisting of chlorine, fluorine and carbon. Example: R12. In many countries it is illegal to release this type of refrigerant to the atmosphere because chlorine damages the earth's atmosphere. CFC refrigerants are not used in modern Thermo King units.

circuit breaker: A thermal device that automatically interrupts an electrical circuit when the current in the circuit exceeds the predetermined amperage rating of the breaker. See *amp*.

coil: A cooling or heating element made of pipe or tube, formed into a helical or serpentine shape, that may be equipped with thin metal fins to aid heat transfer.

cold curtains: Flexible vinyl curtains used to reduce air exchange between the refrigerated compartment and the outside during door openings.

compound gauge: A gauge calibrated in psig (or kPa) to measure pressure, and in inches of mercury (Kg/cm²) to measure vacuum.

compressor: The refrigeration component that compresses refrigerant vapor and creates refrigerant flow.

condenser: An arrangement of tubing in which the vaporized and compressed refrigerant is liquefied as heat is removed.

cycles per second: See *Hertz*.

damper door: A door on the evaporator section that closes during defrost to prevent hot air from entering the refrigerated cargo compartment.

data logger: An electronic device that monitors and stores unit operating and temperature data for later review. Examples: DMS, DAS, DRS and AccuTrac.

DE: Dual Evaporator. A multi-temp host unit with two evaporators capable of refrigerating two separate, longitudinal compartments.

defrost: The removal of accumulated ice from an evaporator coil. Periodic defrost is necessary when the evaporator coil is operating below freezing. Defrost is required more frequently when the air passing through the evaporator has a high moisture content.

defrost termination switch: A component that terminates defrost operation at a specific temperature.

Glossary

defrost timer: A solid state module that initiates defrost at selected intervals. Also establishes a maximum defrost duration if normal circuits malfunction.

dehydrator: A device used to remove moisture from refrigerant. Also called a drier.

discharge air temperature: The temperature of air leaving the evaporator.

drier: See *dehydrator*.

ECT: A ceiling-mounted Thermo King remote evaporator. See *EW* and *TLE*.

ERC: Extended Remote Unit Control. (Door switches) An option on Thermo King multi-temperature units to improve temperature control when doors are opened during delivery. When a compartment door is opened, the refrigeration unit for that compartment may be forced to NULL, defrost, or some other mode. Opening a compartment door may also affect the operating mode of other compartments. ERC systems are connected in a variety of ways to meet customer needs.

ETV (Electronic Throttling Valve) : A device used with a microprocessor to precisely control the refrigeration system.

evaporator: The part of the refrigeration system that absorbs heat during the cooling cycle.

EW: A wall-mounted Thermo King remote evaporator. See *ECT* and *TLE*.

F: See *Fahrenheit*.

Fahrenheit: A unit of temperature measurement used in the United States. Abbreviated “F.”

freeze up: 1) Failure of a refrigeration system to operate normally due to moisture in the refrigerant and the formation of ice at the expansion valve. The expansion valve may be frozen shut or open, causing improper unit operation in either case. 2) The formation of a solid ice mass over the evaporator coil reducing air flow.

fuse: An electrical safety device (typically a cartridge) inserted into an electrical circuit. It contains material that will melt or break when the current is increased beyond a specific value. When this occurs, the circuit is opened and electrical current flow is stopped.

Glossary

fusible link: An electrical safety device (typically a short piece of wire) inserted into an electrical circuit. The wire melts or breaks when the current is increased beyond a specific value. When this occurs, the circuit is opened and electrical current flow is stopped.

HCFC: Hydrochlorofluorocarbon. A chlorine-based refrigerant containing hydrogen, chlorine, fluorine and carbon. Example: R22. Because chlorine damages the earth's atmosphere, in many countries, it is illegal to release this type of refrigerant to the atmosphere. HCFC refrigerants are not used in modern Thermo King units.

Hertz: A unit of frequency equal to one cycle per second. Abbreviated "Hz."

HFC: A refrigerant consisting of hydrogen, fluorine and carbon. Examples: R134a and 404A. HFC refrigerants contain no chlorine and are, therefore, considered "safe" for the environment.

high pressure relief valve: A safety valve on the refrigeration system that allows refrigerant to escape from the system if pressure exceeds a predetermined value.

hp (horsepower): A unit of power equivalent to 746 watts or 550 foot-pounds per second.

HPCO (High Pressure Cut Out Switch): A pressure-operated switch that opens to stop unit operation when discharge pressure reaches a predetermined maximum.

invertible: A multi-temperature truck or trailer unit designed to allow the placement of deep-frozen cargo in any compartment. See *Multi-Temp*.

kPa: Kilopascals. A metric unit of pressure. 1 kPa = 0.01 bar = 0.145 psi.

load: 1) The product being refrigerated and transported.
2) The amount of heat being removed by the refrigeration system. (For example, a compressor is under a heavy heat load when expected to cool a very warm box.)

LPCO (Low Pressure Cut Out Switch): A pressure-operated switch that opens to stop unit operation when suction pressure reaches a predetermined minimum.

modulation: An optional system that reduces load (product) dehydration and avoids "top freeze."

Glossary

movable bulkhead: A thick, insulated, portable wall-like device used to compartmentalize a temperature-controlled truck or trailer. See *bulkhead*.

Multi-Temp: A Thermo King truck or trailer unit capable of maintaining different set-points in multiple compartments.

no. 1 diesel fuel: A grade of diesel fuel formulated to prevent “jelling” in low ambient temperatures.

no. 2 diesel fuel: A grade of diesel fuel formulated for moderate to warm ambient temperatures.

ohm: An electrical unit measuring the amount of resistance (opposition to the current flow) in an electrical circuit.

pre-cooling: 1) To cool down an empty box (temperature-controlled area) to the desired load temperature prior to loading. 2) To cool cargo to a desired temperature before loading.

pre-heat: The heating of diesel engine glow plugs prior to start-up. Some engines use an intake manifold heater rather than glow plugs.

pre-trip inspection: Checking the operation of a refrigeration system before loading.

psi: Pounds per square inch. A unit of pressure.
1 psi = 0.069 bar = 6.89 kPa.

psig: Pounds per Square Inch Gauge. Pressure in pounds per square inch as displayed by a gauge calibrated to zero when open to the atmosphere.

receiver tank: A refrigerant storage device included in nearly all Thermo King units.

refrigerant: The medium of heat transfer in a refrigeration system which absorbs heat by evaporating at a low temperature and releases heat by condensing at a higher temperature.

refrigerant oil: A special oil used to lubricate compressors in refrigeration systems.

remote evaporator: A separate evaporator unit located in a second or third compartment of a multi-temperature truck or trailer unit.

return air bulkhead: A structure (metal or plastic) mounted in the front of a trailer and designed to prevent restriction of return air flow to the Thermo King unit due to improper loading. See *bulkhead*.

Glossary

return air temperature: The temperature of the air returning to the evaporator. See box temperature.

rpm: Revolutions per minute.

setpoint: The temperature selected on a thermostat or microprocessor controller. This is normally the desired box temperature.

short cycling: When a refrigeration unit cycles between the heat and cool modes more often than normal.

sight glass: A system component that permits visual inspection of oil or refrigerant level and condition.

thermostat: A device that controls unit modes of operation to maintain a selected box temperature.

TLE: Thin-line evaporator. A Thermo King remote evaporator designed to be compact (thin) while supplying superior air flow. See *ECT* and *EW*.

top freeze: When the top portion of perishable cargo is damaged by freezing temperatures discharged from the refrigeration unit. This may occur near the front of the box when product is placed too close to the cold, discharge air flow.

Vac (volts alternating current): An electric current that reverses direction at regularly recurring intervals.

Vdc (volts direct current): An electric current that flows in one direction only and is constant in value.

volts: The basic measuring unit of electrical potential.

watt: The basic measuring unit of electrical power.

Emergency Cold Line

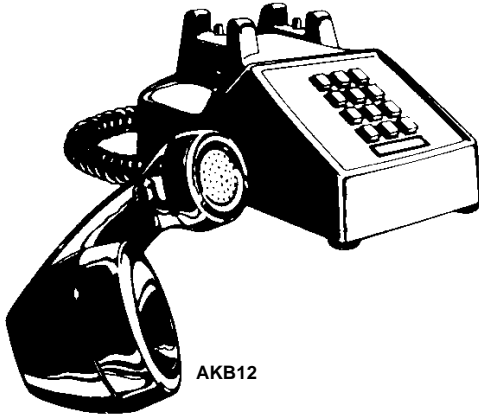

If you can't get your rig rolling, and you have tried the Thermo King North American Service Directory (available from any Thermo King dealer) to reach a dealer without success, *then* call the Toll Free Emergency Cold Line Number (888) 887-2202.

The answering service at the factory will assist you in reaching a dealer to get the help you need. The Cold Line is answered 24 hours a day by personnel who will do their best to get you quick service at an authorized Thermo King Dealer.

Recover Refrigerant

At Thermo King, we recognize the need to preserve the environment and limit the potential harm to the ozone layer that can result from allowing refrigerant to escape into the atmosphere.

We strictly adhere to a policy that promotes the recovery and limits the loss of refrigerant into the atmosphere.

In addition, service personnel must be aware of Federal regulations concerning the use of refrigerants and the certification of technicians. For additional information on regulations and technician certification programs, contact your local THERMO KING dealer.

CALIFORNIA Proposition 65 Warning

**Diesel exhaust is a chemical known to
the State of California to cause cancer.**

Thermo King – by Trane Technologies (NYSE: TT), a global climate innovator – is a worldwide leader in sustainable transport temperature control solutions. Thermo King has been providing transport temperature control solutions for a variety of applications, including trailers, truck bodies, buses, air, shipboard containers and railway cars since 1938. For more information, visit www.thermoking.com or www.tranetechnologies.com

Thermo King has a policy of continuous product and data improvements and reserves the right to change design and specifications without notice. We are committed to using environmentally conscious print practices.

TK 54342-18-OP Feb 2012

©2020 Trane Technologies