



Operator's Manual

V-520 Series Units with Direct Smart Reefer Single and Multi-Temperature Systems

Revision A

Introduction

This manual is published for informational purposes only and the information furnished herein should not be considered as all-inclusive or meant to cover all contingencies. If more information is required, consult your Thermo King Service Directory for the location and telephone number of the local dealer.

Thermo King's warranty shall not apply to any equipment which has been "so installed, maintained, repaired or altered as, in the manufacturer's judgment, to affect its integrity."

Manufacturer shall have no liability to any person or entity for any personal injury, property damage or any other direct, indirect, special, or consequential damages whatsoever, arising out of the use of this manual or any information, recommendations or descriptions contained herein. The procedures described herein should only be undertaken by suitably qualified personnel. Failure to implement these procedures correctly may cause damage to the Thermo King unit or other property or personal injury.

There is nothing complicated about operating and maintaining your Thermo King unit, but a few minutes studying this manual will be time well spent.

Performing pre-trip checks and enroute inspections on a regular basis will minimize operating problems. A regular maintenance program will also help to keep your unit in top operating condition. If factory recommended procedures are followed, you will find that you have purchased the most efficient and dependable temperature control system available.

All service requirements, major and minor, should be handled by a Thermo King dealer for four very important reasons:

- They are equipped with the factory recommended tools to perform all service functions.
- They have factory trained and certified technicians.
- They have genuine Thermo King replacement parts.
- The warranty on your new unit is valid only when the repair and replacement of component parts is performed by an authorized Thermo King dealer.

Software License

The product includes software that is licensed under a non-exclusive, non-sublicensable, terminable and limited license to use the software as installed on the product for its intended purpose. Any removal, reproduction, reverse engineering, or other unauthorized use of the software is strictly prohibited. Hacking the product or installing unapproved software may void the warranty. The owner or operator shall not reverse engineer, decompile, or disassemble the software, except and only to the extent that such activity is expressly permitted by applicable law notwithstanding this limitation. The product may include third party software separately licensed as specified in any documentation accompanying the product or in an about screen on a mobile application or website that interfaces with the product.

Customer Satisfaction Survey

Let your voice be heard!

Your feedback will help improve our manuals. The survey is accessible through any internet-connected device with a web browser.

Scan the Quick Response (QR) code or click or type the web address https://tranetechnologies.iad1.qualtrics.com/jfe/form/SV_2octfSHoUJxsk6x?Q_CHL=qr&Q_JFE=qdg to complete the survey.



Table of Contents

Safety Precautions	7
Danger, Warning, Caution, and Notice	7
General Practices	7
Auto Start/Stop	8
Electrical Hazards	8
Refrigerant Hazards	8
Refrigerant Oil Hazards	9
First Aid	9
Safety Decals	11
Electric Standby Nameplates (Models 20 and 50 Only)	12
Unit Description	14
Introduction	14
Standard Unit Features	15
Optional Features	15
System Components	15
Condenser	15
Evaporator	16
In-Cab Controller	17
Standby Operation (Models 20 and 50 Only)	18
Electrical System	18
Fuses	18
Operating Instructions	20
Introduction	20
Unit Controls	21
Operating the Unit	22

Vehicle Engine Operation	22
Standby Operation (Models 20 and 50 Only).....	22
Entering the Setpoint Temperature	23
Single Temperature Units	23
Multi-Temperature Units.....	24
Initiating Manual Defrost Cycle.....	27
Alarms.....	28
Auto Start (after an alarm)	28
Manual Start (after an alarm).....	28
Clearing Alarm Codes.....	29
Buzzers (Optional)	30
Alarm Code Descriptions	31
Viewing Information Displays.....	32
Main Menu	32
Hourmeter Menu.....	32
Pretrip Inspection (Before Loading Refrigerated Cargo)	33
Unit Operation and Loading Procedures.....	34
Unit Operation (Before Loading Refrigerated Cargo).....	34
Loading Procedure.....	34
Enroute Inspections.....	35
Inspection Procedure	35
Inspection Troubleshooting	36
Specifications	38
Fuses	38
Electric Standby Power Supply Requirements (Models 20 and 50 Only)	38

Refrigerant..... 38

Maintenance Inspection Schedule 39

Warranty..... 41

 Proposition 65..... 41

Serial Number Locations 42

Emergency Cold Line 43

Safety Precautions

Danger, Warning, Caution, and Notice

Thermo King® recommends that all service be performed by a Thermo King dealer and to be aware of several general safety practices.

Safety advisories appear throughout this manual as required (refer to examples below). Your personal safety and the proper operation of this unit depend upon the strict observance of these precautions.

▲ DANGER

Example!

Indicates an imminently hazardous situation which, if not avoided, will result in death or serious injury.

▲ WARNING

Example!

Indicates a potentially hazardous situation which, if not avoided, could result in death or serious injury.

▲ CAUTION

Example!

Indicates a potentially hazardous situation which, if not avoided, could result in minor or moderate injury and unsafe practices.

NOTICE

Example!

Indicates a situation that could result in equipment or property-damage only accidents.

General Practices

▲ DANGER

Risk of Injury!

Keep your hands, clothing, and tools clear of fans and/or belts when working on a unit that is running or when opening or closing compressor service valves. Loose clothing might entangle moving pulleys or belts, causing serious injury or possible death.

Safety Precautions

▲ CAUTION

Sharp Edges!

Exposed coil fins can cause lacerations. Service work on the evaporator or condenser coils is best left to a certified Thermo King technician.

Auto Start/Stop

▲ CAUTION

Risk of Injury!

The unit can start and run automatically any time the unit is turned on. Turn the unit On/Off switch Off before doing inspections or working on any part of the unit. Please note that only Qualified and Certified personnel should attempt to service your Thermo King unit.

▲ CAUTION

Risk of Injury!

Some vehicles may be equipped with an Auto Start-Stop feature allowing the engine to restart automatically if required by the system. Refer to your vehicle's operator's manual regarding the Auto Start-Stop safety warnings before accessing the engine compartment. Failure to do so may result in serious injuries due to automatic engine restart.

Electrical Hazards

NOTICE

Equipment Damage!

Do not connect other manufacturer's equipment or accessories to the unit unless approved by Thermo King. Failure to do so can result in severe damage to equipment and void the warranty.

Refrigerant Hazards

Although fluorocarbon refrigerants (R-404A/R-452A and R-134a) are classified as safe, observe caution when working with refrigerants or around areas where they are being used in the servicing of your unit.

⚠ DANGER

Hazardous Gases!

Refrigerant in the presence of an open flame, spark, or electrical short produces toxic gases that are severe respiratory irritants which can cause serious injury or possible death.

⚠ DANGER

Refrigerant Vapor Hazard!

Do not inhale refrigerant. Use caution when working with refrigerant or a refrigeration system in any confined area with a limited air supply. Refrigerant displaces air and can cause oxygen depletion, resulting in suffocation and possible death.

⚠ WARNING

Personal Protective Equipment (PPE) Required!

Refrigerant in a liquid state evaporates rapidly when exposed to the atmosphere, freezing anything it contacts. Wear butyl lined gloves and other clothing and eye wear when handling refrigerant to help prevent frostbite.

Refrigerant Oil Hazards

Observe the following when working with or around refrigerant oil.

⚠ WARNING

Personal Protective Equipment (PPE) Required!

Protect your eyes from contact with refrigerant oil. The oil can cause serious eye injuries. Protect skin and clothing from prolonged or repeated contact with refrigerant oil. To prevent irritation, wash your hands and clothing thoroughly after handling the oil. Rubber gloves are recommended.

First Aid

REFRIGERANT

- **Eyes:** For contact with liquid, immediately flush eyes with large amounts of water and get prompt medical attention.
- **Skin:** Flush area with large amounts of warm water. Do not apply heat. Remove contaminated clothing and shoes. Wrap burns with dry, sterile,

Safety Precautions

bulky dressing to protect from infection. Get prompt medical attention. Wash contaminated clothing before reuse.

- **Inhalation:** Move victim to fresh air and use Cardio Pulmonary Resuscitation (CPR) or mouth-to-mouth resuscitation to restore breathing, if necessary. Stay with victim until emergency personnel arrive.
- **Frost Bite:** In the event of frost bite, the objectives of First Aid are to protect the frozen area from further injury, warm the affected area rapidly, and to maintain respiration.

REFRIGERANT OIL

- **Eyes:** Immediately flush with large amounts of water for at least 15 minutes. Get prompt medical attention.
- **Skin:** Remove contaminated clothing. Wash thoroughly with soap and water. Get medical attention if irritation persists.
- **Inhalation:** Move victim to fresh air and use Cardio Pulmonary Resuscitation (CPR) or mouth-to-mouth resuscitation to restore breathing, if necessary. Stay with victim until emergency personnel arrive.
- **Ingestion:** Do not induce vomiting. Immediately contact local poison control center or physician.

ENGINE COOLANT

- **Eyes:** Immediately flush with large amounts of water for at least 15 minutes. Get prompt medical attention.
- **Skin:** Remove contaminated clothing. Wash thoroughly with soap and water. Get medical attention if irritation persists.
- **Ingestion:** Do not induce vomiting. Immediately contact local poison control center or physician.

BATTERY ACID

- **Eyes:** Immediately flush with large amounts of water for at least 15 minutes. Get prompt medical attention. Wash skin with soap and water.

ELECTRICAL SHOCK

Take IMMEDIATE action after a person has received an electrical shock. Get quick medical assistance, if possible.

The source of the shock must be quickly stopped, by either shutting off the power or removing the victim. If the power cannot be shut off, the wire should be cut with a non-conductive tool, such as a wood-handle axe or thickly insulated cable cutters. Rescuers should wear insulated gloves and

safety glasses, and avoid looking at wires being cut. The ensuing flash can cause burns and blindness.

If the victim must be removed from a live circuit, pull the victim away with a non-conductive material. Use wood, rope, a belt or coat to pull or push the victim away from the current. **DO NOT TOUCH** the victim. You will receive a shock from current flowing through the victim's body. After separating the victim from power source, immediately check for signs of a pulse and respiration. If no pulse is present, start Cardio Pulmonary Resuscitation (CPR). If a pulse is present, respiration might be restored by using mouth-to-mouth resuscitation. Call for emergency medical assistance.

ASPHYXIATION



Move victim to fresh air and use Cardio Pulmonary Resuscitation (CPR) or mouth-to-mouth resuscitation to restore breathing, if necessary. Stay with victim until emergency personnel arrive.

Safety Decals

Safety decals and locations vary depending on model.

Figure 1. Fan Caution



 	<p>FAN CONTROLLED BY PRESSURE SWITCH, FAN MAY START AUTOMATICALLY AND CAN CAUSE SEVERE INJURY</p>
	<p>VENTILATEUR CONTROLÉ PAR PRESSOSTAT PEUT DÉMARRER AUTOMATIQUEMENT ET PROVOQUER DE SÉVÈRES DOMMAGES</p>
	<p>DRUCKGESTEUERTER LUFTER ACHTUNG: VERLETZUNGSGEFAHR LUFTER KANN AUTOMATISCH STARTEN</p>
	<p>IL MOTORE VENTOLA È REGOLATO CON PRESSOSTATO IL MOTORINO VENTOLA PUÒ AVVIARSI AUTOMATICAMENTE CAUSANDO GRAVI DANNI</p>
	<p>VENTILADOR CONTROLADO POR PRESOSTATO VENTILADOR PUEDE ARANCAR DE FORMA AUTOMÁTICA CAUSANDO GRAVES ELISIONES</p>

SAP1000

Safety Precautions

Figure 2. Automatic Start Caution

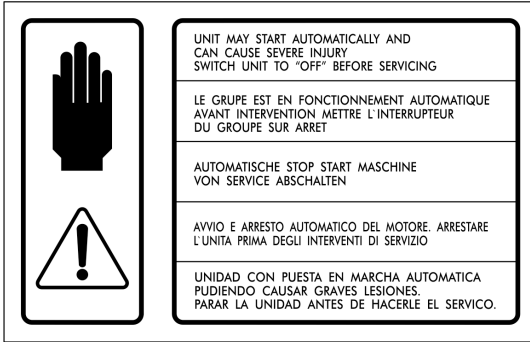

RCS351

Electric Standby Nameplates (Models 20 and 50 Only)

Figure 3. Electrical Hazard Cautions

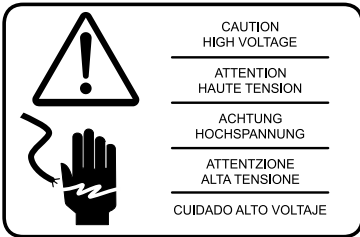
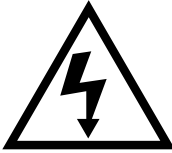

SAP999

Figure 4. Belt Caution

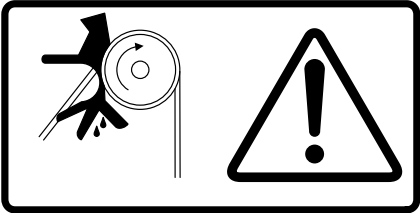

ASA774

Unit Description

Introduction

Thermo King V-520 refrigeration systems are designed for medium-sized trucks and vans transporting fresh, frozen, and deep frozen goods.

The condenser for a RT (roof top) unit is located on the roof top of the vehicle. The condenser on a NM (nose mount) unit is located on the front nose of the cargo box. The evaporator is mounted on the cargo compartment ceiling. SPECTRUM® units have an evaporator in each temperature controlled compartment.

A belt driven compressor running off the vehicle's engine operates the refrigeration system during mobile operation. SmartPower™ models have a second compressor located inside the condenser. This compressor is belt driven off an electric motor when connected to an AC power source during stationary operation.

The user friendly Direct Smart Reefer (DSR) controller makes operating your unit simple, while its design allows for ease of service.

The operating mode is selected automatically: When the unit is connected to an electric power source, engine-driven operation is automatically blocked. If the vehicle engine is started up while the power cable is still connected to the electric power source, the unit will continue to operate in electric standby mode. It is not possible to start the engine-driven compressor until the power cable is disconnected from the unit.

Models includes:

- **Model 10:** Cool and defrost on truck engine driven compressor operation.
- **Model 20:** Cool and defrost on both truck engine driven compressor operation and electric standby compressor operation.
- **Model 30:** Cool, heat, and defrost on truck engine driven compressor operation.
- **Model 50:** Cool, heat, and defrost on both vehicle engine driven compressor operation and electric standby compressor operation.
- **MAX:** For deep frozen applications.
- **SPECTRUM:** Multi-Temperature applications.

Standard Unit Features

- **Condenser** - Lightweight design of aluminium construction, easy to service with automotive grade polypropylene cover.
- **Evaporator** - Ultra slim design, aluminum construction automotive grade Acrylonitrile Butadiene Styrene (ABS) cover.
- **Controls:** DSR (Direct Smart Reefer Controller)

Optional Features

- Electric Standby Power (Model 20 and 50 Units)
- Heat, hot gas (Model 30 and 50 Units Only)
- Door Switch(s)

System Components

The system consists of the following main components:

Condenser

Depending on your model, the condenser will be located either on the roof of the vehicle or on the front of the cargo box.

- V-520 RT 10 and 30 models are made up of two modules: condenser module and a refrigeration module.
- V-520 RT 20 and 50 models are made up of three modules: condenser module, refrigeration module and a electric standby module.
- V-520 nose mount models consist of a single one piece condenser.

The condenser cover(s) can easily be removed to access the fuses or service the unit.

Figure 5. V-520 RT Models 10 and 30 Shown



THERMO KING
Unit Description

1.	Refrigeration Module	2.	Condenser Module
----	----------------------	----	------------------

Figure 6. V-520 RT Models 20 and 50 Shown

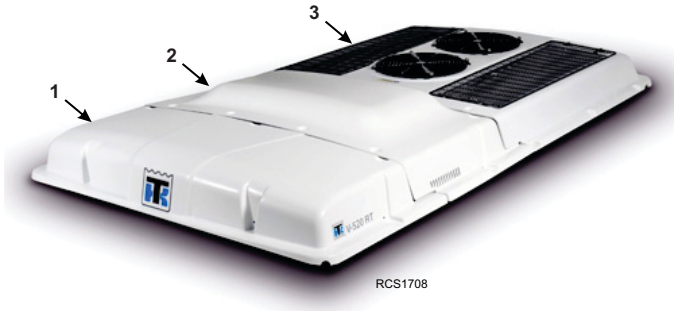

1.	Refrigeration Module	2.	Standby Module	3.	Condenser Module
----	----------------------	----	----------------	----	------------------

Figure 7. V-520 Nose Mount Condenser Shown



Evaporator

The evaporator is mounted on the ceiling inside the cargo box. The cover can easily be removed for service.

Figure 8. Evaporator



In-Cab Controller

⚠ WARNING

Risk of Injury!

Never operate the unit unless you completely understand the controls; otherwise serious injury may occur.

The Direct Smart Reefer (DSR) Controller is mounted in the vehicle cab and is used to operate the refrigeration unit. Refer to Operating Instructions (“Introduction,” p. 20).

Figure 9. DSR In-Cab Controller

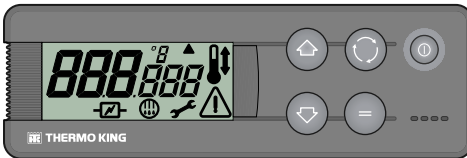

RCS360

Standby Operation (Models 20 and 50 Only)

⚠ WARNING

Hazardous Voltage!

A certified electrician should verify that the proper standby power requirements are being supplied before connecting to a new power source.

These units may be operated in electric standby mode by connecting the proper voltage power cable to the unit's power receptacle mounted on the vehicle. Standby operation is used while the vehicle is stationary with the engine shut off.

Figure 10. Standby Power Receptacle



Electrical System

The unit's controls and refrigeration components operate on 12 Vdc.

SmartPower units have a standby motor that operates on 115 or 230 Vac when connected to a remote power source. A transformer in the condenser unit converts the 115 or 230 Vac to 12 Vdc to operate the unit's controls and refrigeration components.

Fuses

The electrical components are protected by various fuses.

Main Power Fuse - The main power fuse is located in the vehicle's engine compartment and is connected directly to the vehicle's battery.

Ignition Power Fuse - The ignition power fuse is connected to the vehicle's fused ignition system. Depending on the vehicle, the location of the fuse panel could be located inside the cab or under the hood of the vehicle.

Unit Component Fuses - Fuses are located on the controller inside the condenser unit. Remove the condenser cover to access them. Depending on your model, some fuses may not be used.

Other Systems Fuses – These fuses are located outside of the controller and should only be serviced by a authorized Thermo King Dealer.

Figure 11. Controller Fuses

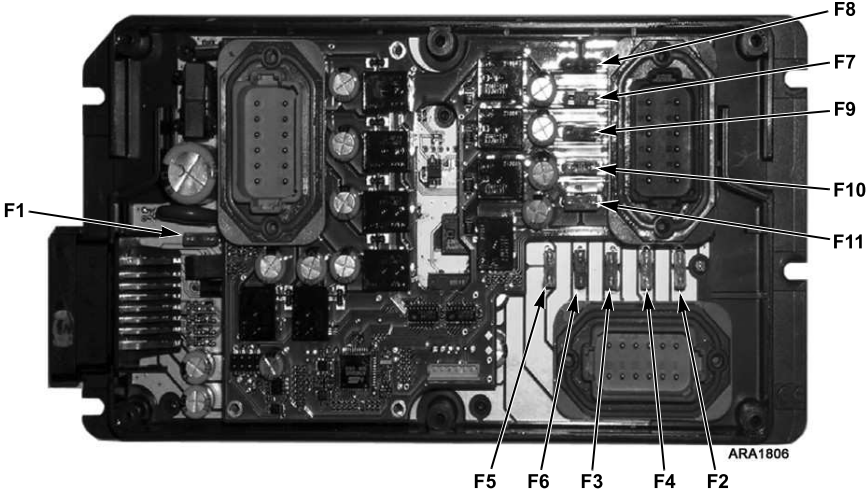

F1.	5 amps	F5.	20 amps	F9.	15 amps
F2.	15 amps	F6.	15 amps	F10.	15 amps
F3.	15 amps	F7.	15 amps	F11.	2 amps
F4.	15 amps	F8.	20 amps		

Operating Instructions

Introduction

In vehicle powered units, temperature control is based on two values: The setting (Setpoint) of the controller and the evaporator return air temperature. The difference between these two temperatures will determine the mode of operation: cool, heat, or null.

Cool: When the temperature in the compartment is 3°F (2°C) *higher* than the setpoint, the unit runs in cool mode to reduce the evaporator return temperature to achieve the setpoint.

Heat: When the temperature in the compartment is 3°F (2°C) *lower* than the setpoint, the unit changes to heat mode to raise the evaporator return temperature to achieve the setpoint.

Null: Once the Setpoint Temperature has been reached, and the temperature remains at or within the temperature differential, (there is no demand for heat or cool), the unit stops operating and goes into the Null mode.

While in the Null mode, the unit is still monitoring the compartment temperature and will resume operation only if the temperature increases or decrease by 3°F (2°C) above or below the setpoint.

Defrost: After a period of time in cool mode, (time is setup during installation between 0 and 8 hours), the unit checks the coil temperature. If the temperature is cold enough to form ice, the unit runs in automatic Defrost Mode to eliminate ice that has accumulated in the evaporator coil. Defrost can also be initiated manually by selecting the defrost mode on the DSR controller. The unit will run in defrost until one of the two events occurs: 1) the coil temperature is back within range, or 2) the defrost termination timer has expired. (time is setup during installation).

Note: *The return air temperature will increase slightly while in defrost, however it will quickly return to the desired setpoint after completion of the defrost cycle.*

Unit Controls

⚠ WARNING

Risk of Injury!

Never operate the unit unless you completely understand the controls; otherwise serious injury may occur.

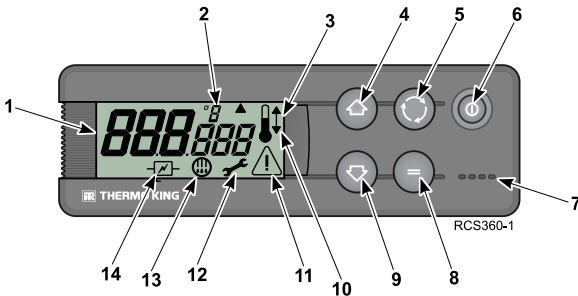

1.	Main Display	Always active and back-lit except when the unit has been manually switched off from the In-Cab Controller. It normally displays the evaporator return air temperature but also displays setpoint temperature, hours, etc. depending on the selection chosen.
2.	C/F Symbol	Indicates temperature reading is in degrees Celsius (C) or degrees Fahrenheit (F).
3.	Heat Symbol	The unit is heating (Thermometer with an arrow pointing upward).
4.	Up Key	Is used to increase the setpoint temperature.
5.	Select Key	Is used to scroll through prompt displays and information displays.
6.	On/Off Key	This key is used to start/stop the unit.
7.	Buzzer	Alerts when vehicle battery and electric power supply are connected simultaneously (Models 20/50 only). Alerts if doors are opened while the refrigeration unit is running (Door Switch Option Only). Can be configured by Thermo King dealer to suit individual customer needs.
8.	Enter Key	Is used to enter a new command such as manual defrost, etc.
9.	Down Key	Is used to reduce the setpoint temperature.

Operating Instructions

10.	Cool Symbol	The unit is cooling (Thermometer with an arrow pointing downward).
11.	Alarm Symbol	Indicates there is an alarm in the system.
12.	Maintenance Symbol	Indicates the need to carry out maintenance to the unit. Refer to (" Maintenance Inspection Schedule ," p. 39).
13.	Defrost Symbol	Indicates the unit is in Defrost Mode.
14.	Electrical Symbol	Indicates the unit is connected to electric standby AC power (Models 20/50 only).

Operating the Unit

Vehicle Engine Operation

1. Start the vehicle's engine.
2. Press the On/Off Key on the DSR controller. The Standard Display will appear.

The Standard Display normally displays the return air temperature and the current operating mode with the appropriate symbol. The example below shows: 38 F temperature and cool mode with an alarm present.

If an alarm is present, the Alarm symbol will also appear on the display. Refer to ("[Alarm Code Descriptions](#)," p. 31).

3. Check the setpoint, and adjust if necessary. Refer to ("[Entering the Setpoint Temperature](#)," p. 23).

Figure 12. Standard Display

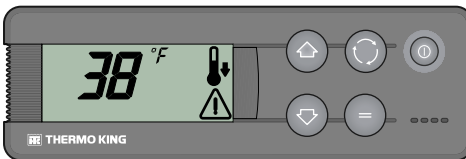

RCS365

Standby Operation (Models 20 and 50 Only)

1. Connect the external power supply to the electric power receptacle. Verify the power supply is the correct voltage, phase and frequency for unit.
2. Press the On/Off Key on DSR controller. The display will be activated. The electric symbol will appear on the display.

3. Check the setpoint, and adjust if necessary. Refer to (“Entering the Setpoint Temperature,” p. 23).

Note: When the unit is connected to an electric power source, engine driven operation is automatically blocked. If the vehicle engine is started up while the power cable is still connected to the electric power source, the unit will continue to operate in electric standby mode and the buzzer will sound (if enabled)

Figure 13. Standard Display with Standby Symbol

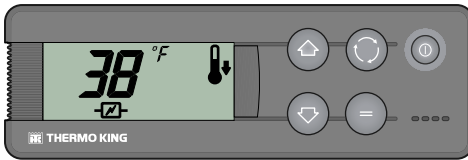

RCS364

Entering the Setpoint Temperature

The Setpoint Temperature can be quickly and easily changed.

Single Temperature Units

1. Press and release the Select key twice and the current Setpoint Temperature and the letters SP will appear on screen.

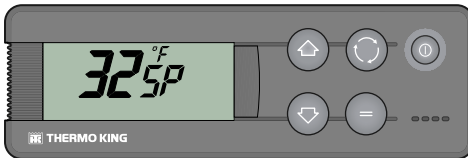

RCS366

2. Press the Up or Down arrow keys to select the desired Setpoint Temperature. Each time either of these buttons is pressed and released, the Setpoint Temperature will change one degree.
3. Press and release ENTER key to set the setpoint or press and release SELECT key to set the setpoint and return to the Standard Display.

Important: If the Select key is not pressed within 20 seconds to select the new Setpoint Temperature, the unit will continue to run at the original Setpoint Temperature.

Note: Once the setpoint has been entered unit operation is fully automatic.

Multi-Temperature Units

1. **Main Load Compartment:** Press and release SELECT key twice, the current Setpoint Temperature in the main compartment and the letters SP will appear on screen.

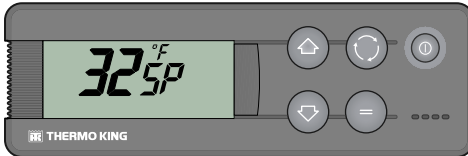

RCS966

2. Press the UP or DOWN arrow keys to select the desired Setpoint Temperature.
3. Press and release ENTER key to set the setpoint or press and release the SELECT key to set the setpoint and to change to the **Remote Compartment** Setpoint Temperature Setting Screen.

Important: If the Select key is not pressed within 20 seconds to select the new Setpoint Temperature, the unit will continue to run at the original Setpoint Temperature.

4. **Remote Load Compartment:** The present Setpoint Temperature in the remote compartment and the letters SP2 will appear on screen.

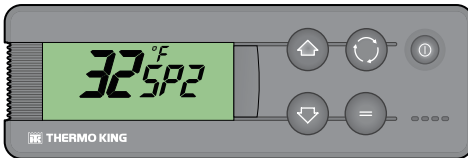

RCS178B

5. Press the UP or DOWN arrow keys to select the desired Setpoint Temperature.
6. Press and release the Enter key to set the set point value or press and release the SELECTION key to set the set point and move to the **CSE (Compartment Selection)** screen.

Important: If the Select key or the Enter key is not pressed within 20 seconds to select the new Setpoint Temperature, the unit will continue to run at the original Setpoint Temperature.

Compartment Selection

1. Press the key UP or DOWN to change option between the four different options available:
 - 1-2: This is the standard multi-temperature setting where both compartments (zones) are active.

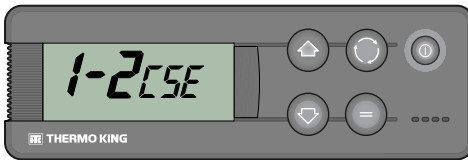

ASA978

The screen shows the temperature in both compartments (zones).

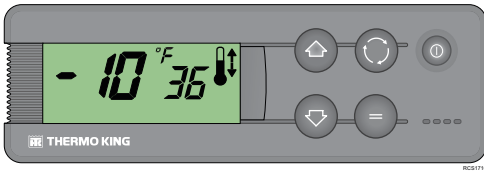

RCS1016

C1: Compartment 1 is active while Compartment 2 is disabled.

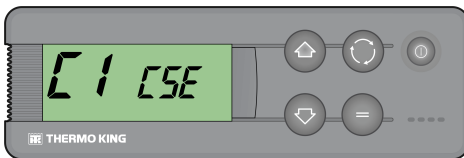

ASA979

Only the temperature for compartment 1 appears on the screen, while no reading is shown for compartment 2.



RCS1011

Operating Instructions

C2: Compartment 2 is active while Compartment 1 is disabled.

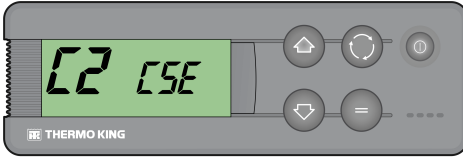

Only the temperature for compartment 2 appears on the screen, while no reading is shown for compartment 1.

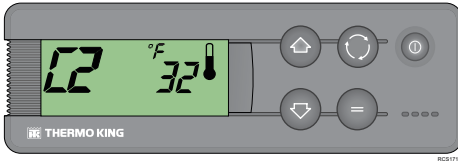

1-1: Compartments 1 and 2 are combined to operate as a single temperature unit; only the temperature for Compartment 1 is displayed.

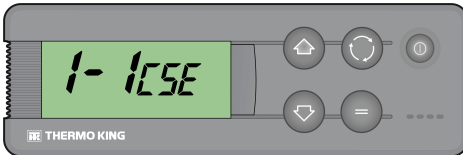

The screen shown as that of a single temperature unit but with the triangle symbol activated to indicate that it is actually a multi-temperature unit operating as a single temperature unit.

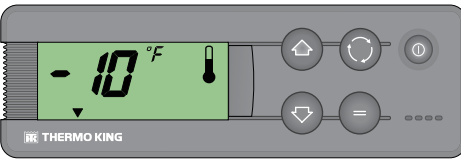

2. Press and release the ENTER key to select an option or press and release the SELECTION key to select an option and return to the standard screen.

Important: If the Select key or the Enter key is not pressed within 20 seconds to select the new Setpoint Temperature, the unit will continue to run at the original Setpoint Temperature.

Initiating Manual Defrost Cycle

Important: Before initiating a manual defrost, verify that the unit is not already in a defrost cycle. When the unit is in a defrost cycle the defrost symbol appears on display.

1. Press and release the Select key once, and the letters dEF will appear (flashing) on display along with the present defrost condition OFF.

Figure 14. Defrost Off

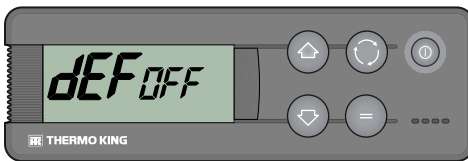

RCS371

2. To activate manual defrost, press the Enter key and then the Up or Down key and the defrost will change to ON.

Figure 15. Defrost On



RCS372

3. Press the Select key twice to return to the Standard Display where the Defrost symbol will appear when the defrost cycle begins.

Note: Manual defrost will be aborted if there is no ice on the coil.

Important: The evaporator coil must be below 36°F (2.26°C) for a defrost to be enabled.

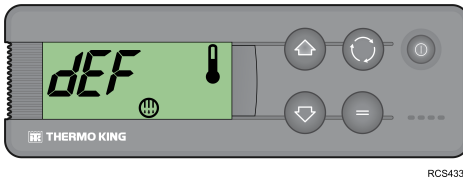
Figure 16. Defrost Cycle in Process

Alarms

When the unit is not operating properly, the microprocessor records the alarm code, alerts the operator by displaying the Alarm symbol, and shuts the unit down. Press and release the Select key to display the current alarm code. If there is more than one active alarm, all the alarm codes on the unit can be viewed in sequence by pressing and releasing the Select key. Refer to (["Alarm Code Descriptions," p. 31](#)).

Auto Start (after an alarm)

When an alarm stops unit operation, the Alarm icon appears on the Standard Display. After the condition that caused the alarm is corrected and the alarm has been cleared, the unit will start automatically. Refer to (["Alarm Code Descriptions," p. 31](#)).

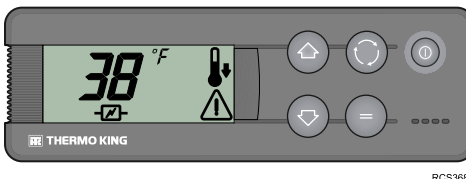
Figure 17. Auto Start Alarm

Manual Start (after an alarm)

When a Manual Start alarm stops unit operation, the Alarm icon appears on the Standard Display with no other icons present.

Note: *This information applies only to the OL (Electric Standby overload) alarm and bAt (low battery voltage) alarm.*

After the condition that caused the alarm is corrected, the On/Off key on the In-cab Control Box must be pressed, in order to start unit operations. Once the unit is powered back up, the alarm must be cleared. Refer to (["Clearing Alarm Codes," p. 29](#)).

Figure 18. Alarm Symbol

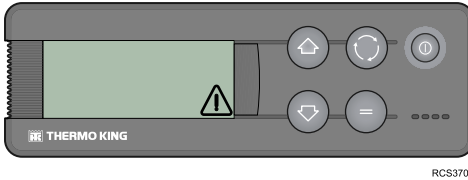

Should a **P1E** alarm occur, return air temperature read error alarm code — will appear on display together with the alarm symbol, instead of the return air temperature reading.

Figure 19. P1E Alarm

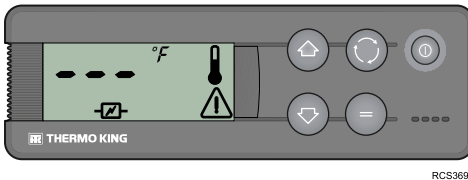

Press and release the Select key to display the current alarm code. If there is more than one active alarm, all the alarm codes on the unit can be viewed in sequence by pressing and releasing the Select key.

Clearing Alarm Codes

The alarm condition in the unit must first be corrected. See important note below. After resolving the alarm condition, press and release the Select key to remove existing Alarm codes. The Standard Display will appear once the Alarm codes have been cleared.

To Clear Alarm Codes:

- Correct the cause of the alarm code.
- Press the Select key to remove the alarm code.
- If more than one alarm code is present, press the Select key to clear each alarm code individually.

Important: Continually clearing alarm codes without resolving the problem will result in damage to the unit and compressor.

Operating Instructions

Notes: *The bAt alarm is the unique DSR-III alarm that requires manual confirmation. The DSR-III will keep in OFF condition until the operator acknowledges and the voltage is above the BCH value(factory setting 10.5v).*

The way to acknowledge this alarm is as follows:

- 1. Press the Select key once to show the Alarm screen. You will now see the bAt Alarm code.*
- 2. Press the Select key again to acknowledge the alarm, and Press the select key again and again until the screen returns to the standard Display.*

Buzzers (Optional)

A buzzer sounds when the vehicle battery and the electrical supply are connected simultaneously (the unit continues running in standby mode). It can also sound if the door(s) is open or the return air temperature is out of range. Buzzers are configurable to different parameters to suit individual customer needs. Contact your Thermo King Dealer for assistance.

Alarm Code Descriptions

Table 1. Color Code Definitions

OK TO RUN		CHECK AS SPECIFIED	TAKE IMMEDIATE ACTION
Alarm	Description		
Manual Start			
bAt		Low Battery Voltage - Check vehicle battery.	
Auto Start			
HP		High Pressure Alarm - The system has detected excessively high discharge pressure. <i>If the problem persists when the unit is restarted, contact your Thermo King Dealer.</i>	
LP		Low Pressure Alarm - The system has detected excessively low suction pressure. <i>If the problem persists when the unit is restarted, contact your Thermo King Dealer.</i>	
PSE		High Pressure Sensor Failure - The high pressure sensor has become faulty or disconnected. <i>Contact your Thermo King Dealer.</i>	
dr1, dr2		Cargo Doors Are Open (Units with door switch option only) - Check if the Doors are open. if not, then the door switches are faulty, or improper door switch configuration. <i>Contact your Thermo King Dealer.</i>	
tCO		Control Module Overheating <i>If the problem persists when the unit is restarted, contact your Thermo King Dealer.</i>	
SOF		Software Failure <i>Contact your Thermo King Dealer.</i>	
P1E		Faulty Cargo Box Return Air Temperature Sensor - Faulty or disconnected return air temperature sensor. <i>Contact your Thermo King Dealer.</i>	
P2E		Remote Cargo Box Return Air Temperature Reading Error (open circuit or short-circuit) <i>Contact your Thermo King Dealer.</i>	

Operating Instructions

Alarm	Description
C	Communications Failure <i>Contact your Thermo King Dealer.</i>
H03	SCM communication lost - Communication lost to Smart Charger Module. <i>If the problem persists when the unit is restarted, contact your Thermo King Dealer.</i>

Viewing Information Displays

Main Menu

From the Standard Display use the Select key to display:

- Alarms (if any active)
- Defrost Status
- Temperature Setpoint

Hourmeter Menu

To open the Hourmeter Menu from the Standard Display, press the Select key for three seconds and release, then press the Select key to display:

- **HC:** Hours remaining to maintenance notice.
- **tH:** The total amount of time unit has been switched on.
- **CC:** Engine-driven compressor operating hours.
- **EC:** Electric standby compressor operating hours.

Pretrip Inspection (Before Loading Refrigerated Cargo)

Pretrip inspections are an important part of preventative maintenance designed to minimize on-the-road operating problems. Perform this visual pretrip inspection before loading refrigerated cargo.

Note: Pretrip inspections are not intended to take the place of regular maintenance inspections.

Figure 20. Visual Pretrip Inspection

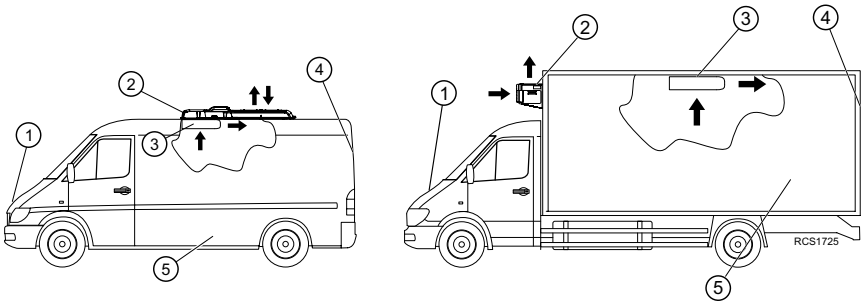

1.	Check that engine driven compressor belt is in good condition.
2.	Check that condenser inlet and outlet areas are clean and free of debris.
3.	Check that evaporator inlet and outlet areas are clean and free of debris and the drain hoses are in place and operational.
4.	Check that doors and seals are in good condition. Doors should latch securely and the seals should fit tightly.
5.	Check interior and exterior of cargo box for damage. Any damage to walls or insulation must be repaired.

Unit Operation and Loading Procedures

This chapter describes unit operation and proper loading procedures. Thermo King refrigeration units are designed to maintain the required product load temperature during transit. Transport refrigeration units are not designed to reduce the load temperature. Follow these recommended procedures to help prevent cargo spoilage.

Unit Operation (Before Loading Refrigerated Cargo)

Start Unit: Adjust the thermostat setting to above and below the compartment temperature to check thermostat operation.

Pre-Cooling: With the thermostat set at the desired temperature, run the unit for half-an-hour to one hour (or until the desired setpoint is reached) before loading the refrigerated cargo. Pre-cooling eliminates residual heat and acts as a good test of the refrigeration system.

Defrost: When the unit has finished pre-cooling the cargo box the evaporator temperature should have dropped below 36°F (2.2°C). Initiate a manual defrost cycle with the In-Cab Controller. The defrost cycle will stop automatically.

Loading Procedure

Important: *Product should be pre-cooled before loading. Thermo King units are designed to maintain the load at the temperature at which it is loaded. Transport refrigeration units are not designed to reduce the load temperature.*

Note: *To minimize frost accumulation in the evaporator coil and a heat increase inside the load compartment, ensure that the unit is OFF before opening the doors.*

1. Carefully check and record the load temperature when loading the refrigerated cargo. Note whether any products are out of temperature range.
2. Load the product to verify sufficient air space is maintained around and through the load in compartment. Airflow around the cargo must not be restricted. DO NOT block the evaporator inlet or outlet. Refer to the Air Circulation Diagram on the following page.

Unit Operation and Loading Procedures

3. Minimize door opening times and close door(s) in between loading to preserve box temperature.

Figure 21. Air Circulation Diagram

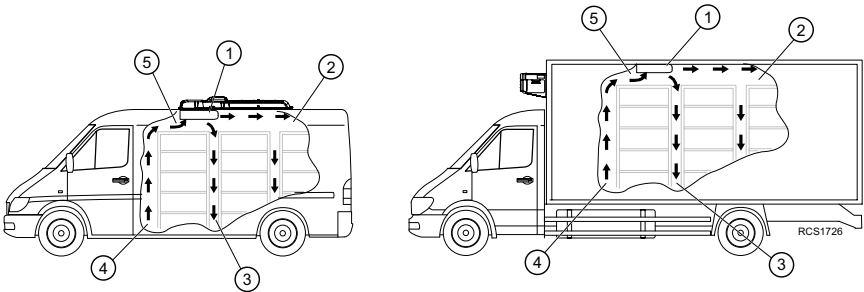

1.	Evaporator air outlet not blocked by cargo.
2.	Sufficient air space is maintained above cargo.
3.	Good air circulation around and between cargo.
4.	Cargo separated from bulkhead and walls a minimum of 4.00 inch (100 mm).
5.	Evaporator air inlet not blocked by cargo.

Enroute Inspections

To help prevent damage to the cargo, complete the following enroute inspection every four hours.

Inspection Procedure

1. Verify the setpoint is correct.
2. Check the return air temperature readings. The temperature readings should be within the desired temperature range. If the readings are not within this range, refer to (Table 2, p. 36).

Inspection Troubleshooting

1. If a return air temperature reading is not within the desired temperature range, refer to (Table 2, p. 36). Correct the problem as needed.
2. Repeat the Enroute Inspection every 30 minutes until the compartment temperature is within the desired temperature range. Stop the unit if the compartment temperature is not within desired temperature range on two consecutive 30 minute inspections, especially if the compartment temperature appears to be moving away from the setpoint.
3. Immediately contact the nearest Thermo King Dealer.
4. Take the necessary steps to protect and maintain proper load temperature.

Table 2. Inspection Troubleshooting

Problem	Cause	Remedy
Return air temperature reading is not within desired temperature range of the setpoint.	Unit has not had time to cool cargo to correct temperature.	Refer to load log history. Look for above temperature load records, properly pre-cooled cargo compartment, length of time on road, etc. Correct as required. Continue monitoring return air temperature until reading is within desired temperature range of the setpoint.
	Unit may have a low refrigerant charge	Contact nearest Thermo King dealer, or call the Thermo King Cold Line for referral.
	Unit is in defrost or has just completed a defrost cycle.	Monitor return air temperature after defrost cycle is completed to see if temperature returns to desired temperature range of the setpoint. Note: <i>Temperature will increase slightly during defrost cycle.</i>
	Evaporator is plugged with frost.	Initiate a manual defrost cycle. Defrost cycle will automatically terminate when complete. Continue monitoring return air temperature until reading is within desired temperature range of the setpoint.

Unit Operation and Loading Procedures

Table 2. Inspection Troubleshooting (continued)

Problem	Cause	Remedy
Return air temperature reading is not within desired temperature range of the setpoint.	Improper air circulation in the cargo compartment.	Inspect unit and cargo compartment to determine if evaporator fans are working and properly circulating the air. Poor air circulation may be due to improper loading of the cargo or shifting of the load. Correct as required. Continue monitoring return air temperature until problem is corrected. <div style="border: 1px solid black; padding: 5px; margin-top: 10px;"> <p style="text-align: center;">⚠ CAUTION</p> <p>Risk of Injury!</p> <p>The unit can start and run automatically any time the unit is turned on. Turn the unit On/Off switch Off before doing inspections or working on any part of the unit. Please note that only Qualified and Certified personnel should attempt to service your Thermo King unit.</p> </div>
	The unit did not start automatically.	Contact nearest Thermo King dealer, or call the Thermo King Cold Line for referral.
	Air leaks in cargo box.	Inspect cargo box for air leaks such as doors that are not fully closed or bad/missing door seals. Repair as necessary.

Specifications

Fuses

See "Fuses," p. 18.

Electric Standby Power Supply Requirements (Models 20 and 50 Only)

				Power Cord Size (AWG) Power Cord Length		
Voltage	Phase	Hz	Power Supply Circuit Breaker	25 ft.	50 ft.	75 ft.
230 (Vac)	1	50/60	16 amp	AWG16/ 1.5mm ²	AWG16/ 1.5mm ²	AWG16/ 1.5mm ²
115 (Vac)	1	50/60	20 amp	AWG14/ 2.5mm ²	AWG14/ 2.5mm ²	AWG14/ 2.5mm ²

Important: Failure to use properly sized power cord may result in improper unit operation, or unit failure.

Refrigerant

All refrigeration service requirements, major and minor, should be handled by a Thermo King dealer.

Maintenance Inspection Schedule

A closely followed maintenance program will help to keep your Thermo King unit in top operating condition. The following general schedule is provided to assist in monitoring that maintenance.

Note: All service requirements, major and minor, should be handled by a Thermo King dealer.

Daily	Weekly	12 Months or 2000 Hours	24 Months or 4000 Hours	Inspect/Check/Service These Items
<ul style="list-style-type: none"> • • • • • 	<ul style="list-style-type: none"> • • 			

Maintenance Inspection Schedule

Daily	Weekly	12 Months or 2000 Hours	24 Months or 4000 Hours	<p style="text-align: center;">Inspect/Check/Service These Items</p>
		<ul style="list-style-type: none"> • • • • 		

*More frequent cleaning may be required based on operating environment (dusty conditions, etc.).

Warranty

Terms of the Thermo King North American Vehicle Powered Truck Unit Limited Warranty are available on request from your Thermo King Dealer. Please reference document TK 51350.

Proposition 65

<p> WARNING: Cancer and Reproductive Harm www.P65Warnings.ca.gov</p>
--

RCS1032

Serial Number Locations

1. **CONDENSER:** Nameplate located on the front inside edge of condenser frame (Cover needs to be removed).
2. **STANDBY COMPRESSOR:** 20 and 50 Models only. Nameplate located on standby compressor body. Standby compressor is located inside the Condenser.
3. **ENGINE DRIVEN COMPRESSOR:** Nameplate located on compressor body. Engine driven compressor is located in the vehicle's engine compartment.

Emergency Cold Line

If you can't get your unit operating and need assistance, you can locate a Thermo King Dealer anywhere in the United States by going to thermoking.com or by using the Thermo King North American Service Directory (available from any Thermo King dealer). If you are unable to reach a dealer, then call the Toll Free Emergency Cold Line Number (888) 887-2202. The answering service will assist you in reaching a dealer to get the help you need. The Cold Line is answered 24 hours a day by personnel who will do their best to get you quick service at an authorized Thermo King Dealer



Thermo King – by Trane Technologies (NYSE: TT), a global climate innovator – is a worldwide leader in sustainable transport temperature control solutions. Thermo King has been providing transport temperature control solutions for a variety of applications, including trailers, truck bodies, buses, air, shipboard containers and railway cars since 1938. For more information, visit www.thermoking.com or www.tranetechnologies.com.

Thermo King has a policy of continuous product and product data improvements and reserves the right to change design and specifications without notice. We are committed to using environmentally conscious print practices.