



THERMO KING

Operator's Manual

Heat King

HK450 HO and HK450 MAX

Revision B

November 2019

TK 56117-6-OP-EN

TRANE
TECHNOLOGIES

Introduction

This manual is published for informational purposes only and the information furnished herein should not be considered as all-inclusive or meant to cover all contingencies. If more information is required, consult your Thermo King Service Directory for the location and telephone number of the local dealer.

Thermo King's warranty shall not apply to any equipment which has been "so installed, maintained, repaired or altered as, in the manufacturer's judgment, to affect its integrity."

Manufacturer shall have no liability to any person or entity for any personal injury, property damage or any other direct, indirect, special, or consequential damages whatsoever, arising out of the use of this manual or any information, recommendations or descriptions contained herein. The procedures described herein should only be undertaken by suitably qualified personnel. Failure to implement these procedures correctly may cause damage to the Thermo King unit or other property or personal injury.

There is nothing complicated about operating and maintaining your Thermo King unit, but a few minutes studying this manual will be time well spent.

Performing pre-trip checks and enroute inspections on a regular basis will minimize operating problems. A regular maintenance program will also help to keep your unit in top operating condition. If factory recommended procedures are followed, you will find that you have purchased the most efficient and dependable temperature control system available.

All service requirements, major and minor, should be handled by a Thermo King dealer for four very important reasons:

- They are equipped with the factory recommended tools to perform all service functions.
- They have factory trained and certified technicians.
- They have genuine Thermo King replacement parts.
- The warranty on your new unit is valid only when the repair and replacement of component parts is performed by an authorized Thermo King dealer.

Customer Satisfaction Survey

Let your voice be heard!

Your feedback will help improve our manuals. The survey is accessible through any internet-connected device with a web browser.

Scan the Quick Response (QR) code or click [Technical Publications TK Americas Feedback](#) to complete the survey.



Table of Contents

Safety Precautions	6
Danger, Warning, Caution, and Notice	6
Safety Decals	6
Blower Fan	6
Automatic Start	7
Hot Surface	7
California Proposition 65 Warning Nameplate	8
General Safety Practices	8
Unit Description	9
Unit Overview	9
Engine	11
HMI Controller	12
Protection Devices	12
Manual Pretrip Inspection	13
Before Starting the Unit	13
Operating Instructions	17
HMI Display Icons	18
HMI Display Icons and Descriptions	19
HMI Display Keys and Descriptions	20
Turning the Unit OFF and OFF	21
Standard Display	21
Changing the Setpoint	22
Starting the Diesel Engine	24
Alarms	25
Alarm Code Types	25
Alarm Code Notification	25

Displaying Alarm Codes	26
Clearing Alarm Codes	27
Table of Alarm Codes	28
Loading and Enroute Inspections	30
Pre-Loading Inspection.....	31
Enroute Inspections.....	31
Specifications	32
Engine Specifications	32
Belt Tension.....	33
Unit Controller	33
Electrical Control System.....	33
Electrical Fuses.....	34
Serial Number Locations	35
Maintenance Inspection Schedule	37
Warranty.....	39
EPA and ARB Supplemental Emissions Warranty Statement.....	39
Troubleshooting	40
Emergency Cold Line	43

Safety Precautions

Danger, Warning, Caution, and Notice

Thermo King® recommends that all service be performed by a Thermo King dealer and to be aware of several general safety practices.

Safety advisories appear throughout this manual as required. Your personal safety and the proper operation of this unit depend upon the strict observance of these precautions. The four types of advisories are defined as follows:

⚠ DANGER

Hazard!

Indicates an imminently hazardous situation which, if not avoided, will result in death or serious injury.

⚠ WARNING

Hazard!

Indicates a potentially hazardous situation which, if not avoided, could result in death or serious injury.

⚠ CAUTION

Hazard!

Indicates a potentially hazardous situation which, if not avoided, could result in minor or moderate injury and unsafe practices.

NOTICE

Hazard!

Indicates a situation that could result in equipment or property-damage only accidents.

Safety Decals

Blower Fan

Be aware of the Fan caution decal near the blower fan.

Figure 1. Fan Warning

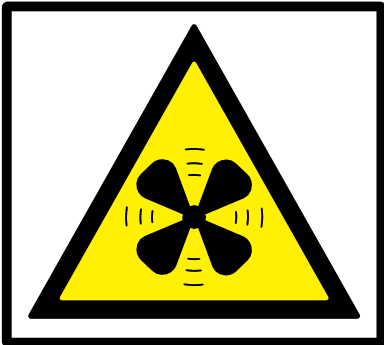

AMA662

Automatic Start

Be aware of the Automatic Start warning decal located inside the unit.

Figure 2. Automatic Start

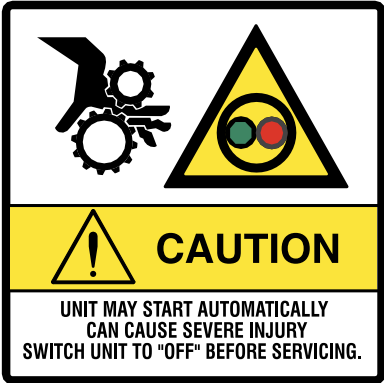

RCS1031

Hot Surface

Be aware of the Hot Surface caution decal inside the unit.

Figure 3. Hot Surface



AMA665

California Proposition 65 Warning Nameplate

Figure 4. P65 Warning Nameplate



RCS1032

General Safety Practices

⚠ DANGER

Risk of Injury!

Keep hands and loose clothing clear of fans and belts at all times when the unit is operating with the doors open.

⚠ WARNING

Risk of Injury!

Do not apply heat to a closed cooling system. Before applying heat to a cooling system, drain it. Then flush it with water and drain the water. Antifreeze contains water and ethylene glycol. The ethylene glycol is flammable and can ignite if the antifreeze is heated enough to boil off the water.

⚠ CAUTION

Sharp Edges!

Exposed coil fins can cause lacerations. Service work on the evaporator or condenser coils should only be accomplished by a certified Thermo King technician.

Unit Description

Unit Overview

Heat King Cargo Heaters are one-piece diesel powered heating units designed for installation onto the front wall of trailers and intermodal containers to provide freeze protection for temperature sensitive cargo. A remote mounted HMI Controller operates the unit and displays unit information. There are two Heat King models:

- HK450 HO (High Output 36,000 BTU)
- HK450 MAX (50,000 BTU)

HK450 HO heat the cargo area by routing heated engine coolant through the radiator coil. A blower in front of the coil transfers the heated air into the cargo box.

HK450 MAX provides additional heating capacity by incorporating an exhaust system heat exchanger. Engine coolant is routed through the heat exchanger and then into the radiator coil. A blower in front of the coil transfers the heated air into the cargo box.

Figure 5. Front view HK450 MAX shown, HK450 HO similar

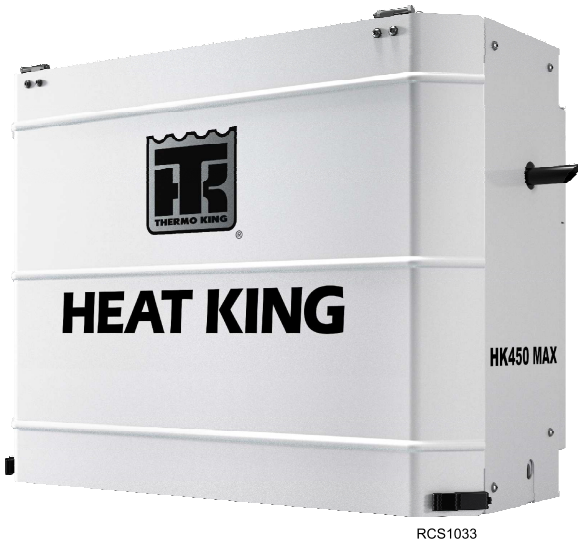
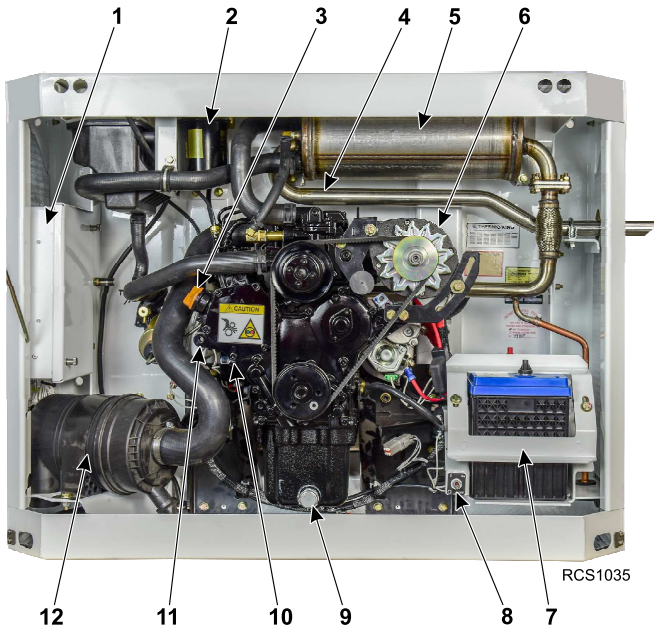

Figure 6. Engine Compartment Components



1.	TG-VII Base Controller
2.	Fuel Filter
3.	Oil Fill Cap
4.	Engine Thermostat
5.	Exhaust Muffler / Heat Exchanger HK450 MAX units only. Exhaust Muffler (not shown) HK450 HO units only.
6.	Alternator
7.	Battery Box and Hold Down Bracket
8.	Maintenance On/Off Switch
9.	Oil Drain Plug
10.	Oil Filter
11.	Oil Level Dipstick
12.	Air Filter

Figure 7. Rear View (all models)



1.	Air Inlet
2.	Air Outlet

Engine

A Thermo King TK 270VF indirect injected two-cylinder, water cooled diesel engine powers the unit. Refer to the Specifications section of this manual for more information.

HMI Controller

The HMI Controller is located in a weather protected enclosure mounted on the outside of the trailer or container. The controller is used by the operator to turn the unit on and off, set desired cargo temperature, and display unit information.

Figure 8. HMI Controller shown mounted in weather protected enclosure



Protection Devices

Main Fuse: A 60 amp fuse protects all unit electrical circuits.

Engine Coolant Temperature Sensor: The engine coolant temperature sensor signals the TG-VII Base Controller to shut down the unit if the engine coolant temperature exceeds the specified limit.

Coolant Level Switch: This switch monitors the coolant level. If coolant level becomes low, an alarm code is displayed on the HMI Controller.

Engine Low Oil Pressure Switch: This switch signals the TG-VII Base Controller to stop the engine if the oil pressure drops below the specified minimum.

Emergency/Maintenance On-Off Switch: This switch cuts power to the TG-VII Base Controller causing an immediate, total unit shutdown when in the off position.

Manual Pretrip Inspection

Before Starting the Unit

Pretrip inspections are an important part of a preventative maintenance program designed to minimize operating problems and breakdowns. Perform this pretrip inspection before every trip involving temperature controlled cargo.

NOTE: *Pretrip inspections are not intended to take the place of regular maintenance inspections.*

Fuel: Make sure the fuel supply is adequate to guarantee engine operation to the next check point.

Engine Oil: Check the engine oil level. It should be at the Full mark when the dipstick is pushed all the way into the oil pan. Do not overfill.

⚠ CAUTION

Service Procedures!

Turn the unit off before attempting to check the engine oil.

Coolant: Remove the coolant filler cap and check the coolant level. Add additional coolant to the expansion tank if necessary. Fill to level of ledge on tank as shown in the illustration.

All Heat King units use Extended Life Coolant (ELC). The maintenance interval for ELC is eight years or 15,000 hours. A nameplate near the coolant expansion tank identifies units with ELC. This coolant is Red instead of the previous Green or Blue-Green coolants. For coolant description see the Specifications section of this manual.

Figure 9. ELC (Extended Life Coolant) Nameplate

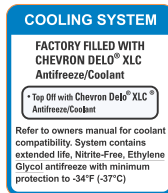

Manual Pretrip Inspection

Important: Only OAT extended life coolants (Chevron Delo® XLC or equivalent) should be added to Thermo King systems. Conventional coolants should not be used (Typically identified by green or blue-green color). If a conventional coolant is combined with the Thermo King factory fill up to 25% by volume, the coolant must be changed at the next service opportunity. Above 25%, the coolant must be changed immediately. Conventional coolants dilute/interact with the additive packages of extended life coolant which significantly reduces the service life of the coolant.

Note: The use of 55/45% pre-mixed ELC is recommended to ensure that deionized water is being used. If 100% full strength concentrate is used, deionized or distilled water is recommended instead of tap water to ensure the integrity of the cooling system is maintained.

Figure 10. Coolant Fill Level

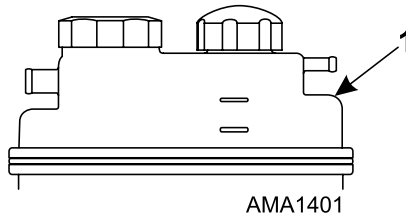

1.	Coolant Fill Level
----	--------------------

⚠ CAUTION**Hazardous Pressures!**

Do not remove expansion tank cap while coolant is hot.

Figure 11. Coolant Expansion Tank and Filler Cap

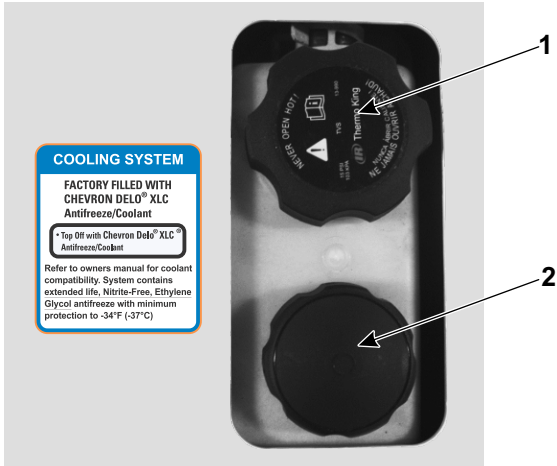

RCS1162

1.	Coolant Expansion Tank Pressure Cap
2.	Coolant Filler Cap (check/add coolant here)

Figure 12. Manual Pretrip Inspection Check Points

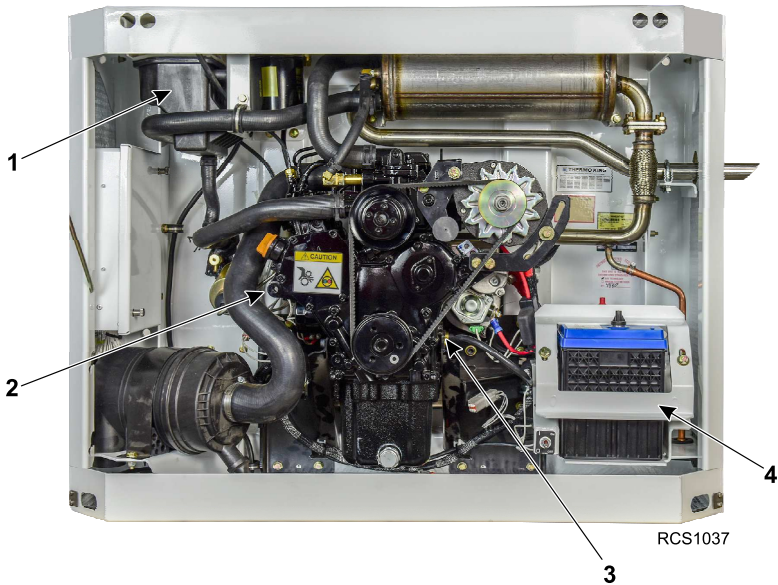

1.	Coolant Expansion Tank	3.	Engine Belt
2.	Oil Level Dipstick	4.	Battery Box and Hold Down Bracket

Battery: Make sure the battery terminals are tight and free of corrosion.

Belt: Make sure the engine belt is in good condition and adjusted to the proper tension.

Cargo Box: Check the interior and exterior of the box for damage. Any damage to the walls or insulation must be repaired.

Doors: Make sure that the doors and weather seals are in good condition. The doors should latch securely and the weather seals should fit tightly.

Electrical: Check all electrical connections to make certain they are securely fastened. Wires and terminals should be free of corrosion, cracks, and moisture.

Leaks: Inspect for fuel leaks, engine oil leaks and coolant leaks.

Radiator (Heating) Coil: Make sure the coil is clean and free of debris.

Structural: Visually inspect the unit for leaks, loose or broken parts, and other damage.

Operating Instructions

The HMI Controller consists of an On/Off Switch, an Hourmeter and the Display and Keypad.

- The ON/OFF Switch is used to turn the unit On and Off.
- The Hourmeter displays Engine Run Time Hours. The right digit shows tenths of an hour.

The Display and Keypad are used to:

- Display box temperature (Return Air Temperature) in °F or °C.
- Display and change the setpoint.
- Display any existing alarm conditions and clear most alarm codes.

Figure 13. HMI Controller

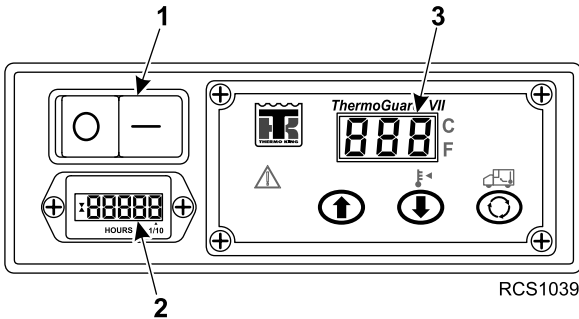

1.	Unit ON/OFF Switch
2.	Hourmeter
3.	Display and Keypad

HMI Display Icons

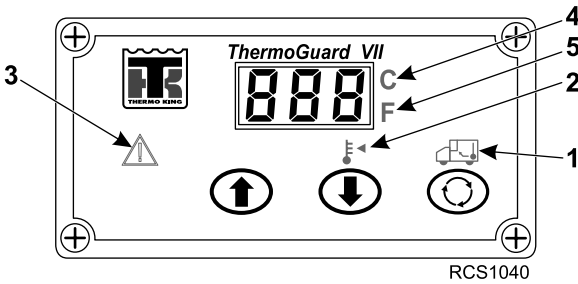

The HMI Controller displays setpoint temperature, box temperature and alarm information to the operator.

Figure 14. HMI Display Icons



1.	Return Air Temperature Icon
2.	Setpoint Icon
3.	Alarm Icon
4.	Red "C" = Centigrade Display
5.	Blue "F" = Fahrenheit Display

HMI Display Icons and Descriptions

	<p>1. Return Air Temperature Icon When the Return Air Temperature Icon is present, the display is showing the actual box temperature inside the cargo box.</p>
	<p>2. Setpoint Icon When the Setpoint Icon is present the display is showing the current setpoint. The setpoint can also be changed when the Setpoint Icon is present.</p>
	<p>3. Alarm Icon When the Alarm Icon is present one or more alarm conditions have occurred.</p> <ul style="list-style-type: none"> • When the unit is first turned on, if the Alarm Icon is on steady yellow for 30 seconds and then turns off, one or more Log Alarms have occurred. • If the Alarm Icon is on steady yellow and does not turn off one or more Check Alarms have occurred. • If the Alarm Icon is flashing red then one or more Shutdown Alarms have occurred and the unit has been shut down. Immediate action must be taken. <p>Consult the Alarm Codes table at the back of this section for suggested corrective actions.</p>
<p style="font-size: 2em; font-weight: bold; text-align: center;">C</p>	<p>4. Red "C" When the red "C" is turned on temperatures are being displayed in degrees Celsius.</p>
<p style="font-size: 2em; font-weight: bold; text-align: center;">F</p>	<p>5. Blue "F" When the blue "F" is turned on temperatures are being displayed in degrees Fahrenheit.</p>
<p>Note: HMI Controller Display of C or F can be set by your Thermo King Dealer.</p>	

HMI Display Keys and Descriptions

The HMI features three touch sensitive keys. Some of these keys have more than one function.

Figure 15. HMI Display Keys and Description

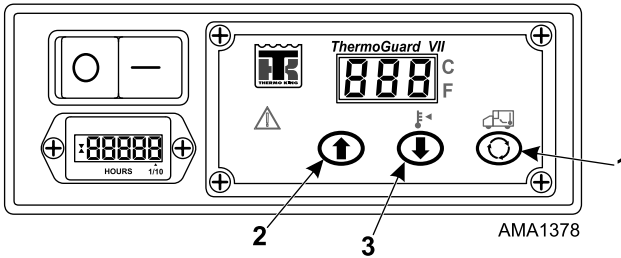

	<p>1. SELECT Key Scrolling: The SELECT Key is used to scroll between the three available displays - Return Air Temperature, Setpoint Temperature and Alarms. Setpoint: When the setpoint is shown on the display and a new setpoint has been chosen using the Up and/or Down Arrow Keys, the SELECT Key must be pressed within about 10 seconds to confirm and load the new setpoint. Alarms: When an alarm code is shown on the display, pressing and holding the SELECT Key will clear that alarm code. Each alarm code must be cleared individually.</p>
	<p>2. UP ARROW Key Setpoint: When the setpoint is shown on the display, pressing the UP ARROW Key will increase the setpoint. Alarms: When an alarm code is shown on the display and more than one alarm code exists, pressing the UP ARROW Key will scroll forward through the existing alarm codes.</p>
	<p>3. DOWN ARROW Key Setpoint: When the setpoint is shown on the display, pressing the DOWN ARROW Key will decrease the setpoint. Alarms: When an alarm code is shown on the display and more than one alarm code exists, pressing the DOWN ARROW Key will scroll backwards through the existing alarm codes.</p>

Turning the Unit OFF and OFF

The unit is turned on and off using the ON/OFF Switch. When the unit is turned on the display briefly shows [888] and all five icons are lighted as the HMI Controller initializes.

Figure 16. ON/OFF Switch

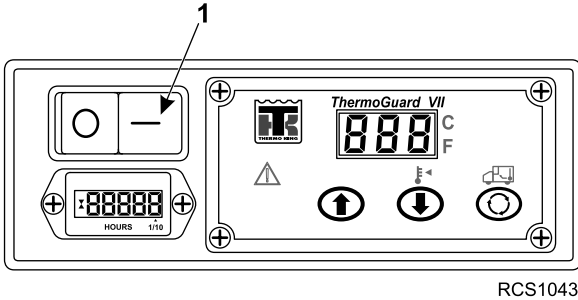

RCS1043

1.	ON/OFF Switch
----	---------------

Standard Display

When the unit is ready to run the Standard Display is shown. This is the default display that appears if no other display function is selected. The Standard Display shows the box temperature as indicated by the Return Air Temperature Icon located above the Select Key. The box temperature shown here is 33°F (1°C) and the hourmeter shows that the unit's diesel engine has run for a total of 18.6 hours.

Figure 17. Standard Display

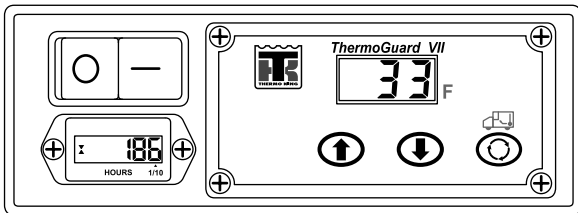

RCS1044

Changing the Setpoint

To change the setpoint, the setpoint must first be shown on the display. From the Standard Display of Box Temperature, press the SELECT Key until the Setpoint Icon appears. When the Setpoint Icon appears the current setpoint will be shown on the display.

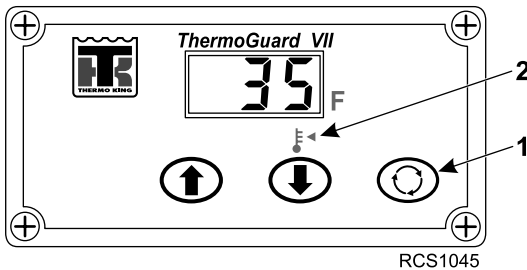

1.	SELECT Key
2.	SETPOINT Icon

When the current setpoint is shown on the display, press the UP ARROW Key and/or DOWN ARROW Key as necessary to chose the new setpoint. Here the setpoint has been increased to 40°F (4°C) using the UP ARROW Key. The factory-established minimum setpoint temperature is -20 F (-29 C) and the maximum is 80 F (27 C).

Figure 18. UP ARROW Key

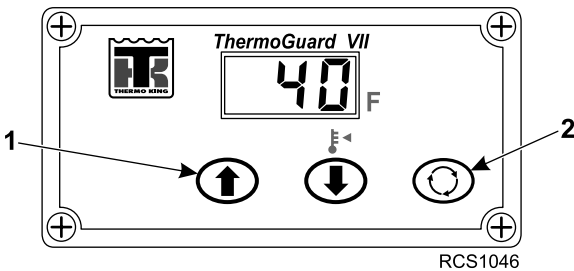

1.	UP ARROW Key
2.	SELECT Key

When the desired setpoint has been selected using the UP ARROW Key and DOWN ARROW Key, the SELECT Key must be pressed within about 10 seconds to confirm and load the new setpoint.

Important: Failure to confirm the new setpoint by pressing the SELECT Key within 10 seconds of changing the setpoint will result in no setpoint change. The setpoint will return to the original setpoint.

After the new setpoint has been confirmed by pressing the SELECT Key, the display will return to the Standard Display. The Return Air Temperature Icon located above the display will appear and the box temperature will be shown in the display.

Figure 19. Return Air Temperature Icon

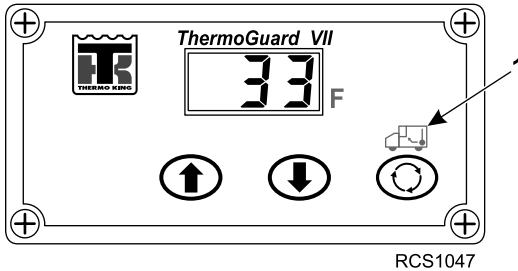

1.	Return Air Temperature Icon
----	-----------------------------

Important: Always check to be sure the desired setpoint has been set.

Note: If the HMI fails, the unit will continue to operate using the current temperature setpoint.

Starting the Diesel Engine

Turn the unit ON using the ON/OFF Switch. Diesel engine preheats and starts are completely automatic. The engine will preheat and start as required when the unit is turned on. The engine pre-heat and start sequence will be delayed if there is no current need for the engine to run.

⚠ WARNING

Risk of Injury!

The unit may start automatically without warning if the Engine On/Off Switch is in the On position.

NOTICE

Equipment Damage!

Never use starting fluid. Damage to the engine can occur.

Figure 20. Standard Display

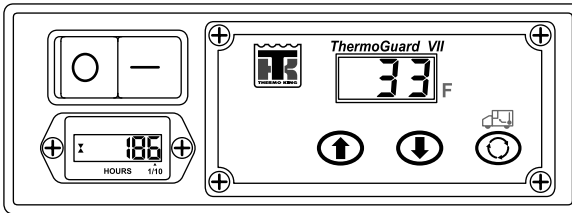

RCS1048

When the engine is preparing to start, the HMI Controller will continue to show the Standard Display. The preheat buzzer (located on the unit TGV-II Base Controller inside the unit) will sound during the engine pre-heat and crank sequence.

Alarms

Alarm Code Types

Log Alarms: This level of alarm serves as a notice to take corrective action before the condition impacts unit performance. Log Alarms are indicated for 30 seconds each time the unit is turned on. Maintenance items such as Check Engine RPM Sensor are Log Alarms.

If Log Alarm(s) are present, the Alarm Icon will appear in yellow on the display for 30 seconds when the unit is first turned on. The Alarm Icon will go off after 30 seconds.

Check Alarms: This level of alarm serves as a notice to take corrective action before a problem becomes severe. The unit will run with Check Alarms but some features and functions may be inhibited.

If Check Alarm(s) are present, the Alarm Icon will appear in yellow on the display and will remain on until the alarm condition is corrected and cleared.

Shutdown Alarms: This level of alarm serves as a notice that continued operation could cause damage to the unit or the load. The unit will be shut down to protect the unit and load.

If Shutdown Alarm(s) are present, the Alarm Icon will flash in red on the display and will remain on until the alarm condition is corrected and cleared. The unit will be shut down. The unit will remain shut down until the Shutdown Alarm is manually cleared.

Alarm Code Notification

If an alarm condition occurs, the Alarm Icon will appear on the Standard Display. If the alarm is a Log Alarm, the yellow Alarm Icon will be displayed for 30 seconds on unit startup. If the alarm is a Check Alarm, the yellow Alarm Icon will turn on and remain on but the unit will continue to run. If the alarm is a Shutdown Alarm, the red Alarm Icon will flash on and off and the unit will shut down. A steady yellow Alarm Icon indicates a Check Alarm has been set.

Figure 21. Alarm Icon

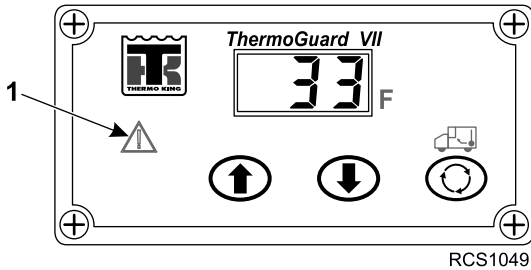

RCS1049

1.	Alarm Icon
----	------------

Displaying Alarm Codes

From the Standard Display of Box Temperature, press the SELECT Key until only the Alarm Icon is shown. When only the Alarm Icon is present the most recent alarm code will be shown on the display.

Figure 22. Display Alarm Codes

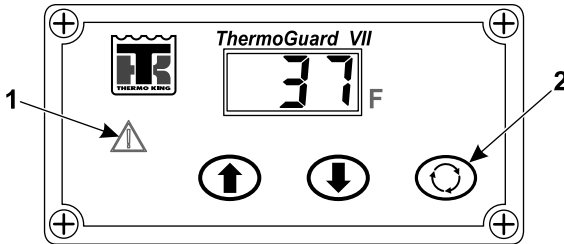

RCS1050

1.	Alarm Icon	2.	SELECT Key
----	------------	----	------------

If more than one alarm code has been set, they are displayed with the most recent alarm shown first. Use the UP ARROW Key and/or DOWN ARROW Key to scroll through the alarms.

Figure 23. UP/DOWN Arrows

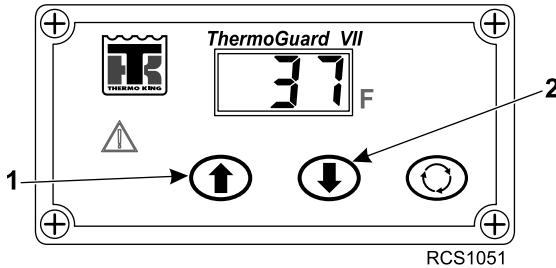

1.	UP Arrow	2.	DOWN Arrow
----	----------	----	------------

Clearing Alarm Codes

After the alarm situation is resolved, display the Alarm Code as shown. Then press and hold the SELECT Key to clear the alarm code currently being displayed. Continue to press and hold the SELECT Key as necessary to clear any remaining alarms. When all alarms have been cleared the display will show all dashes to indicate that no alarm codes exist. The Standard Display will reappear in about 10 seconds.

Figure 24. Clearing Alarm Codes

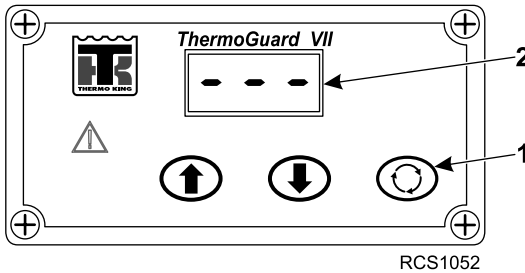

1.	SELECT Key	2.	All Dashes
----	------------	----	------------

Table of Alarm Codes

Important: Alarm notes:

- If an alarm will not clear, it may still exist. If the alarm is not corrected, it will not clear or may be immediately set again.
- Some alarms cannot be cleared using the HMI Controller. These alarms must be cleared by maintenance personnel using PC Monitor.
- Not all alarm codes may be used with all applications.

NUM	Description	Operator Action
-- --	No Alarm Exist	No action required.
03	Check (Control) Return Air Sensor	Manually monitor load temperature. Report alarm at end of the day.
04	Check (Control) Discharge Air Sensor	Manually monitor load temperature. Report alarm at end of the day.
06	Check Coolant Temp Sensor	Report alarm at end of the day.
07	Check Engine RPM Sensor	Report alarm at end of the day.
11	Unit Controlling on Alternate Sensor	Manually monitor load temperature. Report alarm at end of the day.
12	Sensor Shutdown	Both Return Air Temperature and Discharge Air Temperature sensors have failed and unit is shut down. Repair immediately.
13	Sensor Check	Manually monitor load temperature. Report alarm at end of the day.
17	Engine Failed to Crank	If unit is shut down repair immediately. Otherwise, report alarm at end of the day.
18	High Engine Coolant Temperature	If unit is shut down repair immediately. Otherwise, report alarm at end of the day.
19	Low Engine Oil Pressure	If unit is shut down repair immediately. Otherwise, report alarm at end of the day.
20	Engine Failed to Start	If unit is shut down repair immediately. Otherwise, report alarm at end of the day.

Operating Instructions

25	Alternator Check	If unit is shut down repair immediately. Otherwise, report alarm at end of the day.
31	Check Oil Pressure Switch	If unit is shut down repair immediately. Otherwise, report alarm at end of the day.
33	Check Engine RPM	Report alarm at end of the day.
35	Check Run Relay Circuit	If unit is shut down repair immediately. Otherwise, report alarm at end of the day.
37	Check Engine Coolant Level	Report alarm at end of the day.
42	Unit Forced to Low Speed	Report alarm at end of the day.
61	Low Battery Voltage	If unit is shut down repair immediately. Otherwise, report alarm at end of the day.
63	Engine Stopped	If unit is shut down repair immediately. Otherwise, report alarm at end of the day.
68	Internal Controller Fault Code	Report alarm at end of the day.
70	Hourmeter Failure	Report alarm at end of the day.
74	Controller Reset to Defaults	Report alarm at end of the day.
84	Restart Null	Report alarm at end of the day.
128	Engine Run Time Maintenance Reminder	Report alarm at end of the day.
132	Total Unit Run Time Maintenance Reminder	Report alarm at end of the day.

Loading and Enroute Inspections

Heat King units provide freeze protection for temperature sensitive cargo. The unit and the trailer/container should be inspected prior to loading cargo and while enroute to prevent cargo spoilage.

⚠ WARNING

Risk of Injury!
 The unit can start at any time without warning. Press the OFF key on the HMI control panel and place the microprocessor On/Off switch in the Off position before inspecting or servicing any part of the unit.

Figure 25. Pre-Loading Inspection

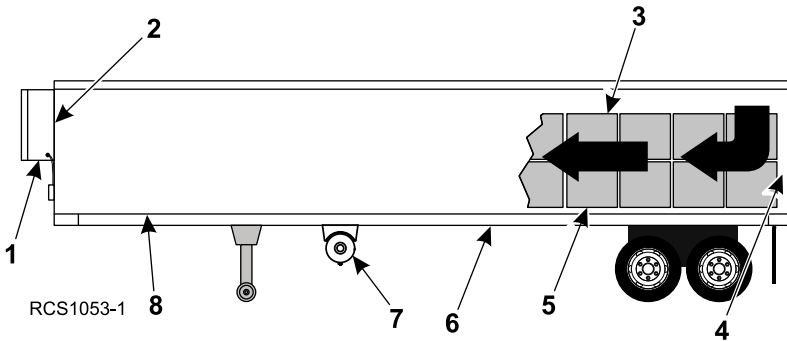

1.	HK pretrip inspection
2.	Heater air inlet and air outlet not restricted
3.	Sufficient air space around and through the load so air flow is not restricted
4.	Tight trailer/container doors and gaskets with no air leakage
5.	Cargo loaded at proper temperature
6.	Interior/exterior walls and insulation in good condition
7.	Sufficient amount of fuel in tank
8.	Floor channels or "T" flooring in good condition, not clogged or damaged

Pre-Loading Inspection

1. Inspect all door seals, including vent doors, for condition and a tight seal with no air leakage.
2. Inspect the cargo compartment inside and out for damaged walls, loose or missing insulation.
3. Inspect the inside of the cargo compartment for damaged air ducts, floor channels or "T" flooring, and clogged or damaged floor channels which could block the air return, creating isolated areas in the load that are difficult to maintain at the desired temperature.
4. Make sure products are at the proper temperature before loading. Any variance should be noted on the manifest.
5. Supervise product loading to make sure that there is sufficient air space around and through the load so air flow is not restricted.
6. Confirm sufficient amount of fuel in tank.

Enroute Inspections

NOTE: Enroute inspections are recommended every four hours for the prevention of damage to the cargo.

1. Note the setpoint to make certain no one has altered the setting since picking up the load.
2. Check for improper air circulation within the cargo compartment. Inspect the cargo compartment (if possible) to determine if air is circulating properly. Poor air circulation can be due to improper loading of the cargo or shifting of the load.

Specifications

Engine Specifications

Engine	Thermo King TK 270VF
Fuel Type	Use Diesel Fuel only No. 2 diesel fuel under normal conditions No. 1 diesel fuel is acceptable cold weather fuel
* Refer to Service Bulletin SB537 for acceptable bio-diesel fuel blends.	
Oil Capacity	Crankcase and filter: 3.1 quarts (2.9 liters) Fill to full mark on dipstick
Oil Type: Mineral Oil Synthetic Oil	API Classification CJ-4 (or better) API Classification CJ-4 (or better)
Oil Viscosity ** Factory Fill	5 to 122 F (-15 to 50 C): SAE 15W-40 -13 to 104 F (-25 to 40 C): SAE 10W-40 -20 to 86 F (-29 to 30 C): SAE 10W-30** -22 to 32 F (-30 to 0 C): SAE 5W-30
Cooling System Capacity	KK450 HO: 4.4 quarts (4.2 liters) HK450 MAX: 8.7 quarts (8.2 liters)
Engine Coolant Type	Factory filled with Chevron Delo® XLC extended life coolant (ELC). 55/45 glycol/water concentration Freeze protection of -40°F/ -40°C Compatible coolants: Chevron Delo® XLC Havoline Delo® XLC (Europe) Caltex Delo® XLC (Asia) OR Meets the performance requirements of both ASTM D6210 and ASTM D3306 OAT extended life coolant, nitrite free
Important: Only OAT extended life coolants (Chevron Delo® XLC or equivalent) should be added to Thermo King systems. Conventional coolants should not be used (Typically identified by green or blue-green color). If a conventional coolant is combined with the Thermo King factory fill up to 25% by volume, the coolant must be changed at the next service opportunity. Above 25%, the coolant must be changed immediately. Conventional coolants dilute/interact with the additive packages of extended life coolant which significantly reduces the service life of the coolant.	

Engine Thermostat	180 F (82 C)
Radiator Cap Pressure	15 psig (103 kPa)

Belt Tension

Note: Use belt tension gauge whenever possible to check belt tension. New belts should be tensioned cold.	
Engine/Alternator/Water Pump	Value of 45 using tension gauge

Unit Controller

Type	TG-VII Base Controller TG-VII HMI
------	--------------------------------------

Electrical Control System

Voltage	12.5 Vdc (nominal)
Battery (Recommended)	Group C31, 12 volt
Battery Charging System	12 V 37 amp alternator
Voltage Regulator Setting	14 V @ 75 F (24 C)

Electrical Fuses

Fuse ID	Rating	Purpose
F1	60A	Main Fuse, all circuits
F2	2A	Display
F3	2A	Remote Light
F4	15A	Maintenance Switch
F5	7.5A	Run Relay
F6	30A	Preheat
F7	40A	Starter/Fuel Solenoid
F8	15A	Fuel Heater
F9	2A	Hourmeter
F11	10A	Power from On Relay
F13	15A	High Speed Solenoid
F14	2A	Alternator
See Maintenance Manual for fuse locations.		

Serial Number Locations

Always reference the unit model and unit serial number when servicing the unit or when ordering replacement parts.

Figure 26. Serial Number Locations



RCS1054

1.	Engine Serial Number Plate - located on top of valve cover
2.	Unit Serial Number Plate - attached to bulkhead

Serial Number Locations

Figure 27. Unit Serial Number Plate

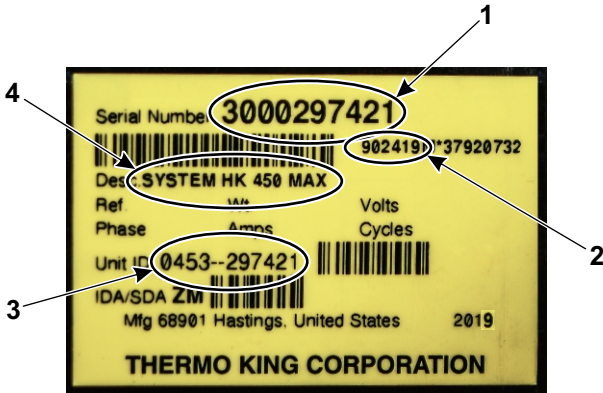

RCS1055-1

1.	Unit Serial Number
2.	Bill of Material Number
3.	Unit ID
4.	Unit Description

Maintenance Inspection Schedule

A closely followed maintenance program will help to keep your Thermo King unit in top operating condition. The following general schedule is provided to assist in monitoring that maintenance.

For more specific detail, see the maintenance manual for your unit and to the PreTrip Inspection chapter in this manual.

After first week of operation:

- Check belt tension
- Tighten unit mounting bolts
- Check coolant level

Monthly	Pre-Trip	Every 1,200 Hours	Annual 3,000 Hours	Inspect/Service These Items
				HMI Controller
•	•			Check seal and operation of protective cover after each use. Inspect for damage to enclosure.
				Engine
				<i>These service intervals require the use of either CJ-4 (or better) mineral oil or synthetic oil.</i>
	•			Check fuel supply
•	•	•		Check engine oil level
•	•	•		Inspect belts for condition and proper tension.
•	•	•		Check engine oil pressure; hot, high speed. Minimum 40 psig (276 kPa, 2.8 bar).
•	•	•	•	Listen for unusual noises, vibrations, etc.
•		•		Dry air cleaner. Replace air cleaner element at 2,000 hours or 1 year (whichever occurs first).
	•	•		Clean and service crankcase breather and check air cleaner hose for damage.

Maintenance Inspection Schedule

		•	•	Drain water from fuel tank and check vent.
		•	•	Check and adjust engine speeds (high and low speed).
			•	Check condition of engine mounts.
			•	Check that engine coolant antifreeze protection is at -40 F (-40 C) every 1,000 hours or 6 months year (whichever occurs first)
			—	Change ELC (red) engine coolant every 8 years or 15,000 hours.
		•		Oil change interval with API classification CJ-4 (or better) mineral oil or synthetic oil. <i>Note: Seasonal oil change is recommended. Refer to Maintenance Manual for long-term storage procedures.</i>
				Electrical
•	•	•	•	Check for charge and discharge (glow plug) operation.
		•	•	Inspect battery terminals and electrolyte level.
		•	•	Check operation of protection shutdown circuits.
		•	•	Inspect wire harness for damaged wires or connections. Check for tight terminal connections.
			•	Inspect DC (battery charging) alternator bearings and brushes.
				Structural
•	•	•	•	Visually inspect unit for fluid leaks.
•	•	•	•	Visually inspect unit for damaged, loose or broken parts (includes air ducts and bulkheads).
		•	•	Inspect lubricant leakage and bearing wear (noise).
		•	•	Check all unit and fuel tank mounting bolts, brackets, lines, hoses, etc.

Warranty

Please contact your nearest Thermo King dealer for terms of the Thermo King North American Heater Unit Limited Warranty.

EPA and ARB Supplemental Emissions Warranty Statement

Your Thermo King unit is covered by the diesel engine manufacturer's EPA and ARB Supplemental Emissions Warranty. Complete details of this emission warranty can be found at www.thermoking.com.

Troubleshooting

The following information is provided to assist you in locating and correcting minor problems. If these procedures do not correct the problem, contact your nearest Thermo King dealer or authorized service center.

Condition	Possible Cause	Remedy	
Unit switch ON - nothing happens	Dead battery	Recharge or replace battery	
	Blown fuse	Turn unit off and correct cause Replace fuse	
	Poor battery connections	Clean and tighten	
	Shutdown alarm	See Alarm Codes section of this manual	
	Unit maintenance switch is switched OFF	Turn switch to ON position	
Unit switch ON - indicator lights come on but engine does not crank	Corroded battery connections	Clean and tighten	
Engine cranks but fails to start	No fuel or wrong fuel in tank	Fill fuel tank After filling a completely empty tank, bleed fuel system	
	Engine too cold	Preheat unit for correct amount of time; see Starting Instructions	
	Glow plugs defective	Replace glow plugs	
	Air in fuel system	Bleed fuel system Also check if fuel lines are tight and filters are clean	
	Air in injection pump	Bleed fuel system	
	Defective electric fuel pump	Replace fuel pump	
	Plugged electric fuel pump	Remove restriction	
	Engine stops after starting	Fuel filter obstructed	Replace filter element

 **THERMO KING**
Troubleshooting

	Low oil pressure	Add oil Check for leaks
	Vent of fuel tank obstructed	Remove obstruction
	Shutdown alarm	See Alarm Codes section of this manual
Engine does not reach full power	Dirt or air in fuel system	Bleed or clean fuel system
	Fuel line leaks	Tighten fuel line connections If necessary, replace damaged lines
	Fuel filter blocked	Install new filter
	Electric fuel pump filter dirty	Clean or replace filter
	Air filter clogged	Clear air filter
	Fuel tank vent clogged	Unclog vent
Engine is sooting heavily, emits black clouds of smoke (excessive fuel to air ratio)	Wrong fuel	Drain and refill with correct fuel grade
	Clogged intake filter	Clear air filter
	Restricted exhaust system	Clean exhaust
	Oil being drawn in	Check oil level in oil bath air filter
	Insufficient air	Clear air filter
Engine knocks	Insufficient air	Clean air filter
	Air in fuel system	Bleed fuel system
	Engine is cold	Warm up engine
	Fuel return line plugged	Remove restriction
	Dirty radiator	Clean radiator
Engine runs hot	Engine coolant is low, oil pressure too low or drops suddenly	Add coolant slowly while engine is operating Check oil level, add if necessary

Troubleshooting

	Dirty or plugged radiator	Clean radiator
	Cooling system heavily scaled	Clean cooling system
	Worn or loose belt	Replace belt or adjust
Oil pressure too low or drops suddenly	Insufficient oil in pan	Refill oil pan after correcting cause of loss
	Leak in oil line	Tighten oil line fittings
High oil consumption	Oil leaks	Check and eliminate possible causes
	Clogged air cleaner	Clean air cleaner
	Crankcase breather blocked	Clean crankcase breather
Blue smoke (oil consumption)	Excessive oil consumption	Refer to high oil consumption (above) Repair as necessary
White smoke (fuel is not burning)	Cold engine	Allow engine to warm up
	Air or water in fuel	Bleed system. Replace filters, clean fuel system, drain and clean tank and check supply tank for water Use known good fuel
	Insufficient preheat	Check glow plugs
Battery not charging	Loose alternator belt	Tighten belt
	Loose connections in the electrical system	Check all electrical connections and charging system
	Battery defective	Replace
	Alternator defective	Replace

Emergency Cold Line

If you can't get your unit operating and need assistance, you can locate a Thermo King Dealer anywhere in the United States by going to thermoking.com or by using the Thermo King North American Service Directory (available from any Thermo King dealer). If you are unable to reach a dealer, then call the Toll Free Emergency Cold Line Number (888) 887-2202. The answering service will assist you in reaching a dealer to get the help you need. The Cold Line is answered 24 hours a day by personnel who will do their best to get you quick service at an authorized Thermo King Dealer



Thermo King – by Trane Technologies (NYSE: TT), a global climate innovator – is a worldwide leader in sustainable transport temperature control solutions. Thermo King has been providing transport temperature control solutions for a variety of applications, including trailers, truck bodies, buses, air, shipboard containers and railway cars since 1938. For more information, visit www.thermoking.com or www.tranetechnologies.com.

Thermo King has a policy of continuous product and product data improvements and reserves the right to change design and specifications without notice. We are committed to using environmentally conscious print practices.